



Administrative Permit Staff Report

Meeting Date: February 2, 2017

Subject: Administrative Permit Case Number WADMIN16-0001
Applicant: Carlson and Associates
Agenda Item Number: 8C
Summary: Conversion of a portion of the first floor of an existing commercial office building into four residential apartments.
Recommendation: Approval with Conditions
Prepared by: Roger Pelham, MPA, Senior Planner
Washoe County Community Services Department
Planning and Development Division
Phone: 775.328.3622
E-Mail: rpelham@washoecounty.us

Description

Administrative Permit Case Number WADMIN16-0001 (Mays Building) - Hearing, discussion, and possible action to approve an Administrative Permit to allow the conversion of a portion of the first floor of an existing commercial office building into four residential apartments. The first floor of the building is 3662 square feet in size. Approximately 600 square feet is proposed to remain as a commercial office and approximately 3000 square feet is proposed to be converted into residential space.

- Applicant/Property Owner: Tim Carlson
9 Silver Saddle Court
Washoe Valley, NV 89704
- Location: 795 Mays Blvd, Incline Village NV. Approximately 150 feet south of the intersection of Mays Boulevard and Southwood Boulevard
- Assessor's Parcel Number: 127-090-04
- Parcel Size: ± 0.54 acres
- Master Plan Category: Urban Residential (UR)
- Regulatory Zone: Medium Density Urban (MDU)
- Area Plan: Tahoe
- Citizen Advisory Board: Incline Village/Crystal Bay
- Development Code: Authorized in Article 808, Administrative Permits
- Commission District: 1 – Commissioner Berkbigler
- Section/Township/Range: Section 16, T16N, R18E, MDM,
Washoe County, NV

Staff Report Contents

Project Description..... 1
Administrative Permit Definition 3
Vicinity Map 4
Site Plan 5
Project Evaluation 7
Incline Village Crystal Bay Citizen Advisory Board (IVCBCAB) 7
Reviewing Agencies..... 7
Recommendation..... 8
Motion..... 9
Appeal Process..... 9

Exhibits Contents

Conditions of Approval.....Exhibit A
Agency Comment Letters.....Exhibit B
Public Notice..... Exhibit C
Project Application Exhibit D
Public Comment LetterExhibit E

Administrative Permit Definition

The purpose of an Administrative Permit is to provide a method of review for a proposed use which possess characteristics that requires a thorough appraisal in order to determine if the use has the potential to adversely affect other land uses, transportation or facilities in the vicinity. The Board of Adjustment or the Hearing Examiner may require conditions of approval necessary to eliminate, mitigate, or minimize to an acceptable level any potentially adverse effects of a use, or to specify the terms under which commencement and operation of the use must comply. Prior to approving an application for an administrative permit, the Hearing Examiner or the Board of Adjustment must find that all of the required findings, if applicable, are true.

The Conditions of Approval for Administrative Permit Case Number WADMIN16-0001 are attached to this staff report and will be included with the Action Order, if approved by the Board of Adjustment.

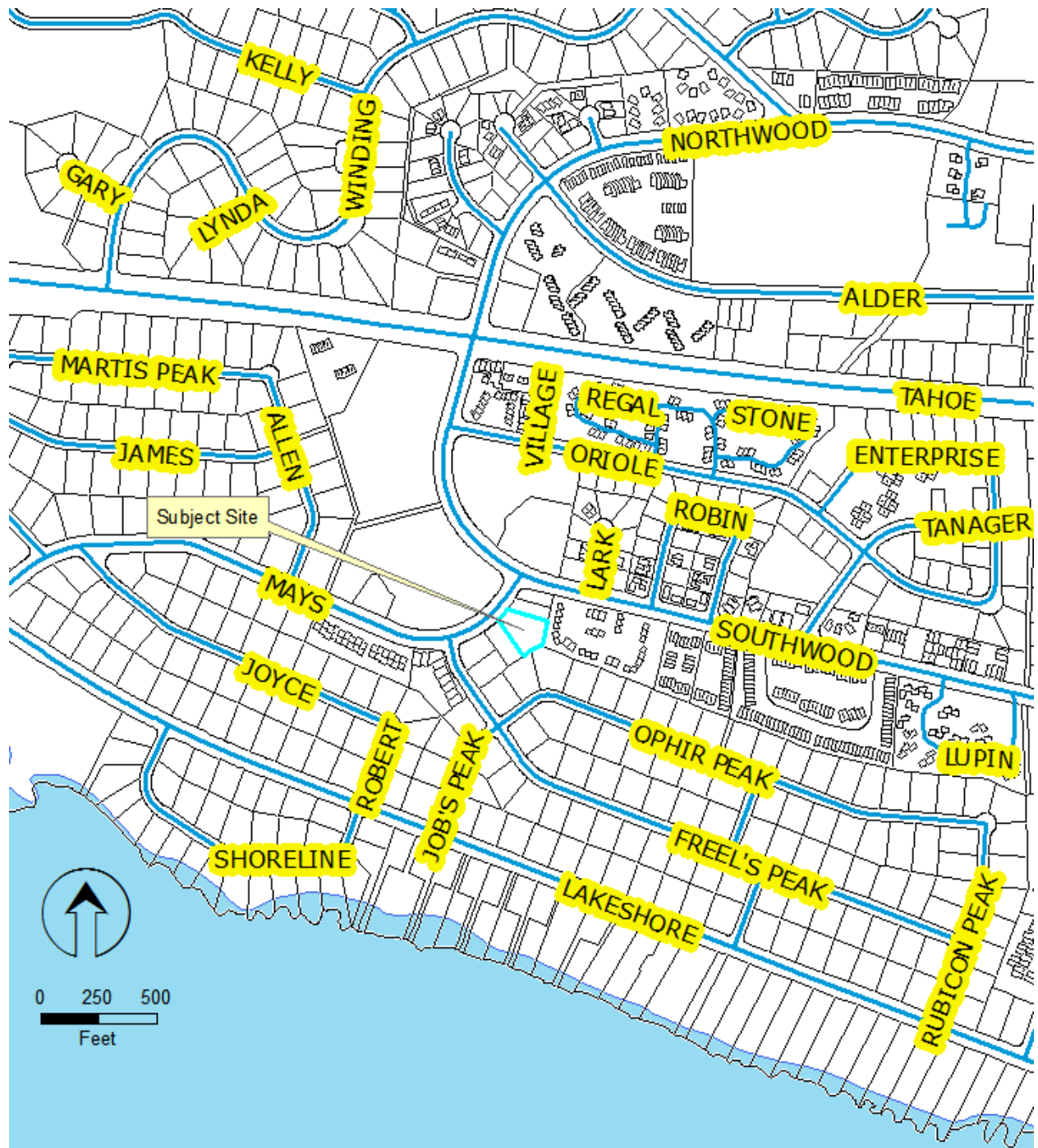

Vicinity Map

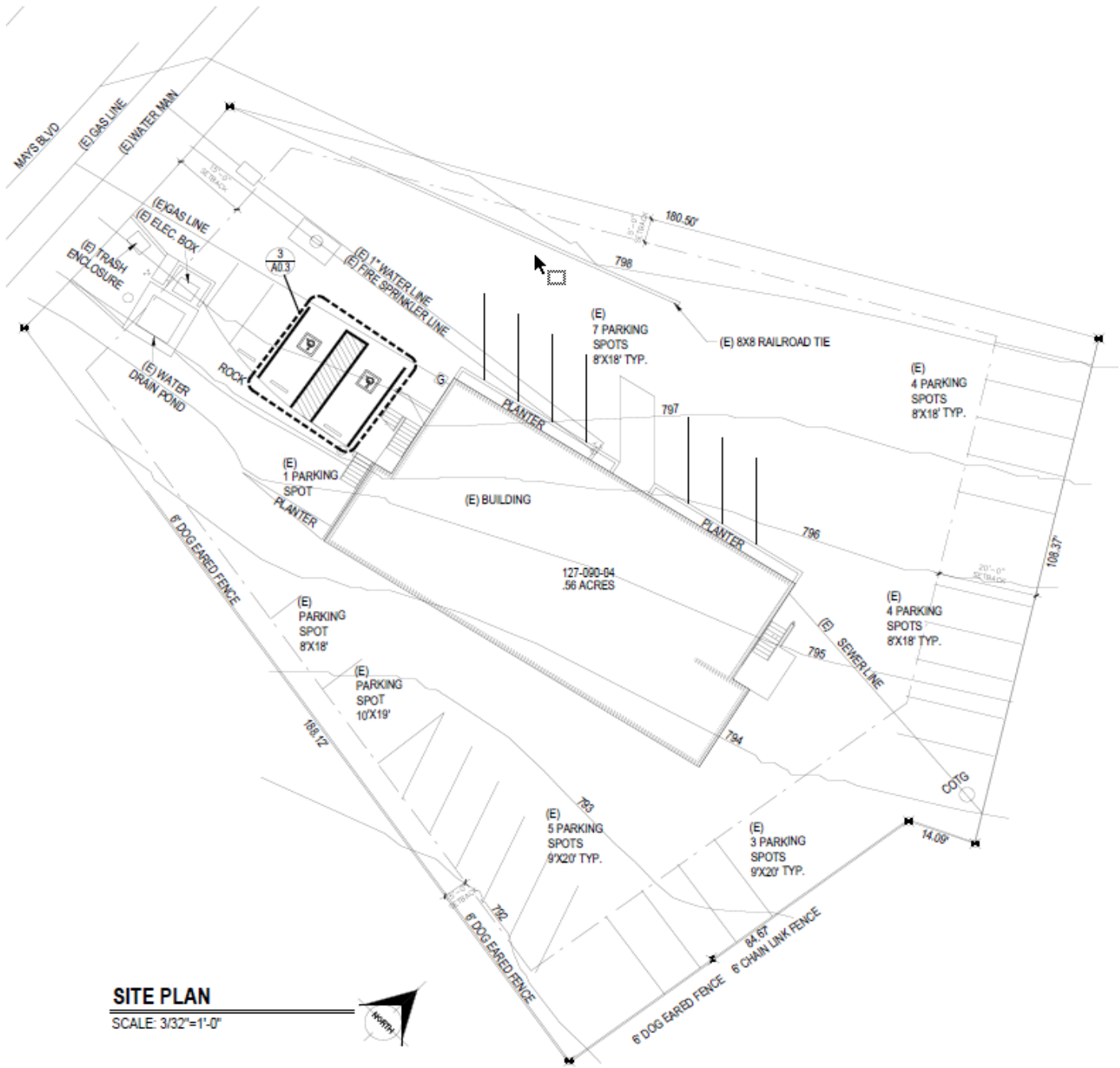

SITE PLAN

SCALE: 3/32"=1'-0"

Site Plan



Project Evaluation

The applicant is requesting to convert commercial offices into residential apartments within an existing building. The parcel is 0.54 acres in size and the Medium Density Urban (MDU) regulatory zone allows for 21 dwellings to the acre. This allows for a potential total of 11 dwellings on the subject parcel. Including the current request (and the six existing residential units) a total of 10 dwellings are proposed. Multi-Family dwellings are permissible in the MDU regulatory zone upon approval of an Administrative Permit in accordance with Table 110.302.05.1 (Table of Uses, Residential Use Types) of the Development Code.

The exterior of the building will not be modified. There is sufficient area for parking and sufficient lighting existing at this time. Potential traffic to the site will likely be reduced. Residential apartments require one parking space to be within a garage or a carport. A condition of approval has been recommended to require compliance with that requirement. There will be no changes to drainage, as there is no grading proposed. The applicant, however, must meet the minimum requirements for landscaping as provided for Washoe County Code (WCC) Chapter 110, Article 412, which includes 20% of the site being landscaped and certain buffers between the parking area and the property lines. A condition of approval has been recommended to require that final plans include the improvements as required.

The existing structure is within a residential regulatory zone, Medium Density Urban (MDU). The existing structure is surrounded by similar residential development. The existing office will remain in use as an existing, non-conforming use. Staff has not identified negative impacts associated with the conversion of a portion of the existing structure from offices to apartments.

Incline Village/Crystal Bay Citizen Advisory Board (IV/CB CAB)

Administrative permits are not required by WCC Chapter 110 to be presented at a Citizen Advisory Board meeting.

Reviewing Agencies

The following agencies received a copy of the project application for review and evaluation.

- Washoe County Community Services Department
 - Building and Safety Division
 - Engineering and Capital Projects Division
 - Roads, Operations
 - Planning and Development Division
- Washoe County Health District
 - Air Quality Management
 - Environmental Health Services Division
 - Vector-Borne Diseases Program
- Washoe County School District
- North Lake Tahoe Fire Protection District
- Regional Transportation Commission
- Washoe-Storey Conservation District
- Incline Village General Improvement District
- Nevada State Lands
- Tahoe Regional Planning Agency
- Tahoe Transportation District

Eight of the above listed agencies/departments responded. Comments and recommended conditions of approval, in response to their evaluation of the project application, were minimal. Most noted that they had no comment or that there was no anticipated impact associated with the proposal. District Health provided one condition that simply restates Health Code regarding regular disposal of waste, and Planning and Development included standard conditions as well as one condition of approval requiring compliance with landscaping requirements, as noted above. The recommended conditions of approval are attached as Exhibit A and will be included with the Action Order, if the application is approved by the Board of Adjustment.

Staff Comment on Required Findings

Section 110.808.25 of Article 808, *Administrative Permits*, within the Washoe County Development Code, requires that all of the following findings be made to the satisfaction of the Washoe County Board of Adjustment before granting approval of the administrative permit request. Staff has completed an analysis of the application and has determined that the proposal is in compliance with the required findings as follows:

1. Consistency. That the proposed use is consistent with the action programs, policies, standards and maps of the Master Plan and the Tahoe Area Plan.

Staff Comment: Residential apartments are allowed in the MDU regulatory zone.

2. Improvements. That adequate utilities, roadway improvements, sanitation, water supply, drainage, and other necessary facilities have been provided, the proposed improvements are properly related to existing and proposed roadways, and an adequate public facilities determination has been made in accordance with Division Seven.

Staff Comment: The conversion of offices to apartments will not result in additional impacts upon utilities, roads, sewer, water and other necessary facilities.

3. Site Suitability. That the site is physically suitable for residential apartments, and for the intensity of such a development.

Staff Comment: The structure is existing and will not be externally altered.

4. Issuance Not Detrimental. That issuance of the permit will not be significantly detrimental to the public health, safety or welfare; injurious to the property or improvements of adjacent properties; or detrimental to the character of the surrounding area.

Staff Comment: None of the reviewing agencies indicated that the proposal would result in a significant detriment to the public health, safety or welfare or be injurious to the property or improvements of adjacent properties or detrimental to the character of the surrounding area.

5. Effect on a Military Installation. Issuance of the permit will not have a detrimental effect on the location, purpose or mission of the military installation.

Staff Comment: There is no military installation in the required noticing distance of the project, therefore this finding is not required to be made.

Recommendation

Those agencies which reviewed the application had no comment, or recommended minimal conditions, on the approval of the project. Therefore, after a thorough analysis and review, Administrative Permit Case Number WADMIN16-0001 is being recommended for approval with conditions. Staff offers the following motion for the Board's consideration.

Motion

I move that, after giving reasoned consideration to the information contained in the staff report and information received during the public hearing, the Board of Adjustment approve Administrative Permit Case Number WADMIN16-0001 for Carlson and Associates, with the Conditions of Approval included as Exhibit A to this matter, having made all four required findings in accordance with Washoe County Code Section 110.808.25:

1. Consistency. That the proposed use is consistent with the action programs, policies, standards and maps of the Master Plan and the Tahoe Area Plan;
2. Improvements. That adequate utilities, roadway improvements, sanitation, water supply, drainage, and other necessary facilities have been provided, the proposed improvements are properly related to existing and proposed roadways, and an adequate public facilities determination has been made in accordance with Division Seven;
3. Site Suitability. That the site is physically suitable for residential apartments, and for the intensity of such a development; and
4. Issuance Not Detrimental. That issuance of the permit will not be significantly detrimental to the public health, safety or welfare; injurious to the property or improvements of adjacent properties; or detrimental to the character of the surrounding area;

Appeal Process

Board of Adjustment action will be effective 10 calendar days after the written decision is filed with the Secretary to the Board of Adjustment and mailed to the original applicant, unless the action is appealed to the Washoe County Board of County Commissioners, in which case the outcome of the appeal shall be determined by the Washoe County Board of County Commissioners. Any appeal must be filed in writing with the Planning and Development Division within 10 calendar days after the written decision is filed with the Secretary to the Board of Adjustment and mailed to the original applicant.

Applicant: Tim Carlson
 9 Silver Saddle Court
 Washoe Valley, NV 89704



Conditions of Approval

Administrative Permit Case Number WADMIN16-0001

The project approved under Administrative Permit Case Number WADMIN16-0001 shall be carried out in accordance with the Conditions of Approval granted by the Board of Adjustment on February 2, 2017. Conditions of Approval are requirements placed on a permit or development by each reviewing agency. These Conditions of Approval may require submittal of documents, applications, fees, inspections, amendments to plans, and more. These conditions do not relieve the applicant of the obligation to obtain any other approvals and licenses from relevant authorities required under any other act or to abide by all other generally applicable Codes, and neither these conditions nor the approval by the County of this project/use override or negate any other applicable restrictions on uses or development on the property.

Unless otherwise specified, all conditions related to the approval of this Administrative Permit shall be met or financial assurance must be provided to satisfy the conditions of approval prior to issuance of a grading or building permit. The agency responsible for determining compliance with a specific condition shall determine whether the condition must be fully completed or whether the applicant shall be offered the option of providing financial assurance. All agreements, easements, or other documentation required by these conditions shall have a copy filed with the County Engineer and Planning and Development.

Compliance with the conditions of approval related to this Administrative Permit is the responsibility of the applicant, his/her successor in interest, and all owners, assignees, and occupants of the property and their successors in interest. Failure to comply with any of the conditions imposed in the approval of the Administrative Permit may result in the initiation of revocation procedures.

Washoe County reserves the right to review and revise the conditions of approval related to this Administrative Permit should it be determined that a subsequent license or permit issued by Washoe County violates the intent of this approval.

For the purpose of conditions imposed by Washoe County, “may” is permissive and “shall” or “must” is mandatory.

Conditions of Approval are usually complied with at different stages of the proposed project. Those stages are typically:

- Prior to permit issuance (i.e., grading permits, building permits, etc.).
- Prior to obtaining a final inspection and/or a certificate of occupancy.
- Prior to the issuance of a business license or other permits/licenses.
- Some “Conditions of Approval” are referred to as “Operational Conditions.” These conditions must be continually complied with for the life of the project or business.

The Washoe County Commission oversees many of the reviewing agencies/departments with the exception of the following agencies.

- **The DISTRICT BOARD OF HEALTH, through the Washoe County Health District, has jurisdiction over all public health matters in the Health District.**

Any conditions set by the Health District must be appealed to the District Board of Health.

FOLLOWING ARE CONDITIONS OF APPROVAL REQUIRED BY THE REVIEWING AGENCIES. EACH CONDITION MUST BE MET TO THE SATISFACTION OF THE ISSUING AGENCY.

Washoe County Planning and Development Division

1. The following conditions are requirements of the Planning and Development Division, which shall be responsible for determining compliance with these conditions.

Contact Name – Roger Pelham, 775.328.3622, rpelham@washoecounty.us

- a. The applicant shall demonstrate substantial conformance to the plans approved as part of this administrative permit.
- b. The applicant shall submit complete construction plans and building permits shall be issued within two years from the date of approval by Washoe County and the Tahoe Regional Planning Agency. The applicant shall complete construction within the time specified by the building permits.
- c. The applicant shall attach a copy of the action order approving this project to all administrative permit applications (including building permits) applied for as part of this administrative permit.
- d. Best practice design guidelines shall be implemented to mitigate visual impacts.
- e. There shall be complete screening of roof mounted HVAC equipment.
- f. The plans shall show at least one parking space, within a garage or sheltered by a carport, set aside for the exclusive use of each of the residential apartments within the building. Apartment numbers shall be displayed on each garage or carport to indicate the exclusive use of that parking space.
- g. The plans shall show a minimum of 20% of the subject parcel improved with landscaping, and a buffer area around the parking area in accordance with Article 412 shall also be constructed, prior to the certificate of occupancy for any of the new apartments.
- h. A note shall be placed on all construction drawings and grading plans stating:

NOTE:

Should any prehistoric or historic remains/artifacts be discovered during site development, work shall temporarily be halted at the specific site and the State Historic Preservation Office of the Department of Museums, Library and Arts shall be notified to record and photograph the site. The period of temporary delay shall be limited to a maximum of two (2) working days from the date of notification

- i. The following **Operational Conditions** shall be required for the life of the development:
 1. This administrative permit shall remain in effect until or unless it is revoked or is inactive for one year.
 2. Failure to comply with the conditions of approval shall render this approval null and void. Compliance with this condition shall be determined by the Planning and Development Division.

3. The applicant and any successors shall direct any potential purchaser/operator of the site and/or the administrative permit to meet with the Planning and Development Division to review conditions of approval prior to the final sale of the site and/or the administrative permit. Any subsequent purchaser/operator of the site and/or the administrative permit shall notify the Planning and Development Division of the name, address, telephone number, and contact person of the new purchaser/operator within 30 days of the final sale.

Washoe County Health District

2. The following conditions are requirements of the Health District, which shall be responsible for determining compliance with these conditions. The District Board of Health has jurisdiction over all public health matters in the Health District. Any conditions set by the Health District must be appealed to the District Board of Health.

Contact Name – Wes Rubio, 775.328.2434, wrubio@washoecounty.us

- a. Periodic solid waste removal of animal confinement areas to prevent odors, flies, and other vectors must be in accordance with section 040.069 of the District Board of Health Regulations Governing the Prevention of Vector-Borne Diseases.

*** End of Conditions ***

**WASHOE COUNTY
HEALTH DISTRICT**
ENHANCING QUALITY OF LIFE

January 5, 2017

Roger Pelham, MPA, Senior Planner
Washoe County Community Services
Planning and Development Division
PO Box 11130
Reno, NV 89520-0027

RE: Mays Building; APN 127-090-04
Administrative Permit; WADMIN16-0001

Dear Mr. Pelham:

The Washoe County Health District, Environmental Health Services Division (Division) Engineering has reviewed the above referenced project. Approval by this Division is subject to the following conditions:

1. The WCHD has reviewed the above proposed administrative permit and has **no objections to the approval of the permit as proposed.**
2. The property must comply with the following:
 - a. Periodic solid waste removal of animal confinement areas to prevent odors, flies and other vectors must be in accordance with section 040.069 of the District Board of Health Regulations Governing the Prevention of Vector-Borne Diseases.

If you have any questions or would like clarification regarding the foregoing, please contact Wes Rubio, Senior Environmental Health Specialist at wrubio@washoecounty.us regarding all Health District comments.

Sincerely,



Bob Sack, Division Director
Environmental Health Services Division
Washoe County Health District

BS:wr

Cc: File - Washoe County Health District



WADMIN16-0001_FIRE_no_comment

From: Emerson, Kathy
Sent: Tuesday, December 20, 2016 12:01 PM
To: Mark Regan
Cc: Pelham, Roger; Giesinger, Chad; Krause, Eva
Subject: RE: December Agency Review Memo II - WC Planning & Development

Thank you, Mark!

From: Mark Regan [mailto:mregan@nltfpd.net]
Sent: Tuesday, December 20, 2016 11:52 AM
To: Emerson, Kathy
Subject: RE: December Agency Review Memo II - WC Planning & Development

Morning,

NLTFPD is good with all 3 Items

From: Emerson, Kathy [mailto:KEmerson@washoecounty.us]
Sent: Tuesday, December 20, 2016 11:40 AM
To: Mark Regan
Subject: December Agency Review Memo II - WC Planning & Development

Good Morning,

Please find the attached Agency Review Memo II with cases received in December by Washoe County Community Services Department, Planning & Development.

You've been asked to review the below-listed application as indicated. The item descriptions and links to the applications are provided in the memo. Please remember to send any agency review responses/comments directly to the Planner for the case, rather than replying to me.

NLTFPD: Items 1, 2, 4

Thank you!

Kathy Emerson
Administrative Secretary Supervisor | Community Services Department
kemerson@washoecounty.us | 775-328-3615 | 1001 E. 9th St., Reno, NV 89512
www.washoecounty.us/csd



WASHOE COUNTY

COMMUNITY SERVICES DEPARTMENT

Engineering and Capital Projects Division

"Dedicated to Excellence in Public Service"

1001 East 9th Street PO Box 11130 Reno, Nevada 89520 Telephone: (775) 328-2040 Fax: (775) 328-3699

INTEROFFICE MEMORANDUM

DATE: December 30, 2016
TO: Roger Pelham, Planning and Development Division
FROM: Leo R. Vesely, P.E., Engineering and Capitol Projects Division
SUBJECT: **WADMIN16-0001**
APN 127-090-04
MAYS BUILDING APARTMENTS

I have reviewed the referenced administrative permit case and have **no conditions or comments.**

LRV/lrv

WADMIN16-0001
EXHIBIT B

WADMIN16-0001_Conservation_District_no_comment

From: Emerson, Kathy
Sent: Tuesday, December 20, 2016 4:56 PM
To: Pelham, Roger; Krause, Eva
Subject: Comments from NTCD - December Agency Review Memo II - WC Planning & Development

Roger - Case WADMIN16-0001 (Mays Building)

Eva - Case WPVAR16-0003 (Snyder Garage)

From: Meghan Kelly [mailto:mkelly@ntcd.org]
Sent: Tuesday, December 20, 2016 4:51 PM
To: Emerson, Kathy
Subject: RE: December Agency Review Memo II - WC Planning & Development

Thanks Kathy,

I do not have any comments.

Meghan Kelly, P.E.
Senior Project Engineer/District Manager
Nevada Tahoe Conservation District
Office: (775) 586-1610 ext. 30
Cell: (775)901-9251
Fax: (775) 586-1612
www.ntcd.org

NTCD's Mission Statement
To promote the conservation and improvement of the Lake Tahoe Basin's natural resources
by providing leadership, education, and technical assistance to all basin users.

From: Emerson, Kathy [mailto:KEmerson@washoecounty.us]
Sent: Tuesday, December 20, 2016 12:00 PM
To: mkelly@ntcd.org
Subject: December Agency Review Memo II - WC Planning & Development

Good Morning Meghan,

Mark with NTCD gave me your email address. We have sent these agency review memos to Doug Martin in the past. Sometimes the planners in our department would like input from NTCD on our cases. In this case, they are asking if you have comments and or conditions for items 1 and 4.

If you have questions or if I should send this to someone else, please let me know.

Kathy

From: Emerson, Kathy
Sent: Tuesday, December 20, 2016 11:35 AM
To: 'dmartin@ntcd.org'
Subject: December Agency Review Memo II - WC Planning & Development

Good Morning,

Please find the attached Agency Review Memo II with cases received in December by Washoe County Community Services Department, Planning & Development.



REGIONAL TRANSPORTATION COMMISSION

Metropolitan Planning • Public Transportation & Operations • Engineering & Construction
Metropolitan Planning Organization of Washoe County, Nevada

December 21, 2016

FR: Chrono/PL 183-16

Mr. Roger Pelham, Senior Planner
Community Services Department
Washoe County
P.O. Box 11130
Reno, NV 89520

RE: WADMIN16-0001 (Mays Building)
WPVAR16-0001 (Meyer-McSherry)
WPVAR16-0002 (Sierra RV Storage Lot)
WPVAR16-0003 (Snyder Residence)
WSUP16-0001 (Ophir Hill)

Dear Mr. Roger Pelham,

We have reviewed the above applications and have **no comments at this time.**

Thank you for the opportunity to comment on these applications. Please feel free to contact me at 775-332-0174 or rkapuler@rtcwashoe.com if you have any questions or comments.

Sincerely,

Rebecca Kapuler
Planner

RK

Copies: Bill Whitney, Washoe County Community Services
Chad Giesinger, Washoe County Community Services
Eva Krause, Washoe County Community Services
Jae Pullen, Nevada Department of Transportation, District II
Tina Wu, Regional Transportation Commission
Daniel Doenges, Regional Transportation Commission
Julie Masterpool, Regional Transportation Commission
David Jickling, Regional Transportation Commission

Washoe County no comment 01032017

From: Crump, Eric S
To: Pelham, Roger
Cc:
Subject: FW: December Agency Review Memo II - WC Planning & Development

Message December Agency Review Memo II.pdf (206 KB)

Roger:

I have **not comments** relative to

Administrative Permit Case Number WADMIN16-0001 (Mays Building)

Eric Crump
Operations Division Director
Washoe County Community Services Department
775.328.2182 (office)
775.386.3129 (cell)
ecrump@washoecounty.us
3101 Longley Ln., Reno, NV 89502



Connect with us:

Email: www.washoecounty.us/cMail

Twitter: www.twitter.com/washoecounty

Facebook: www.facebook.com/washoecounty

 Please consider the environment before printing this e-mail

Pelham, Roger

From: Krause, Eva
Sent: Tuesday, January 03, 2017 9:53 AM
To: Pelham, Roger
Subject: FW: WADMIN16-001 (Mays Building)

Your Case

From: Boster, Mike [<mailto:MBoster@washoeschools.net>]
Sent: Wednesday, December 28, 2016 04:15 PM
To: Krause, Eva
Subject: WADMIN16-001 (Mays Building)

Hi Eva,

Four new apartments in Incline will have a negligible impact on WCSD facilities and operations. All 3 schools in Incline Village are well under capacity. Hope this is helpful. Thank you for the opportunity to comment.

Mike Boster
Washoe County School District
775.789.3810
mboster@washoeschools.net



Development Review Status Sheet

Date: 12-21-16

Attention: rpelham@washoecounty.us

RE:	795 Mays	
APN:	127-090-04	
Service Address:	795 Mays Incline Village NV 89451	
Owner:	Tim Carlson	
Phone:	Fax:	Email:
Mailing Address: Tim Carlson 9 Silver Saddle Court Washoe Valley, NV 89704		

Administrative Permit Case Number WADMIN16-0001 (Mays Building)
Hearing, discussion, and possible action to approve an Administrative Permit to allow the conversion of a portion of the first floor of an existing commercial office building into four residential apartments. The first floor of the building is 3662 square feet in size, approximately 600 square feet is proposed to remain as a commercial office and approximately 3000 square feet is proposed to be converted into residential space.
Assessor's Parcel Number(s): 127-090-04

- Parcel Size: ± 0.54 acres
- Master Plan Category: Urban Residential (UR)
- Regulatory Zone: Medium Density Urban (MDU)
- Area Plan: Tahoe
- Citizen Advisory Board: Incline Village / Crystal Bay
- Development Code: Article 808, Administrative Permits
- Commission District: 1 – Commissioner Berkbigler
- Section/Township/Range: Section 16, T16N, R18E, MDM, Washoe County, NV
- Staff: Roger D. Pelham, MPA, Senior Planner Washoe County Community Services Department Planning and Development Division

Phone: 775-328-3622
E-Mail: rpelham@washoecounty.us

Comments and Conditions: IVGID has pre-approved this plan per IVGID water and sewer ordinance.

Completed by: Tim Buxton, Chief Inspector
Phone: (775) 832-1246 Fax: (775) 832-1260
Incline Village General Improvement District, 1220 Sweetwater Road, Incline Village NV 89451

The contents of this transmission are intended only for the individual or entity to which it is addressed and may contain information that is privileged, confidential, and exempt from disclosure under applicable law. If the reader of this message is not the intended recipient, you are hereby notified that any dissemination, distribution, or copying of this communication is strictly prohibited. If you receive this communication in error, please notify us immediately by telephone and return the original to us at the above address via US Postal Service. We will reimburse you for your postage. Thank you.

Note: Send information to the case planner as prescribed on the memo from Dawn or the Washoe County Development. TLB

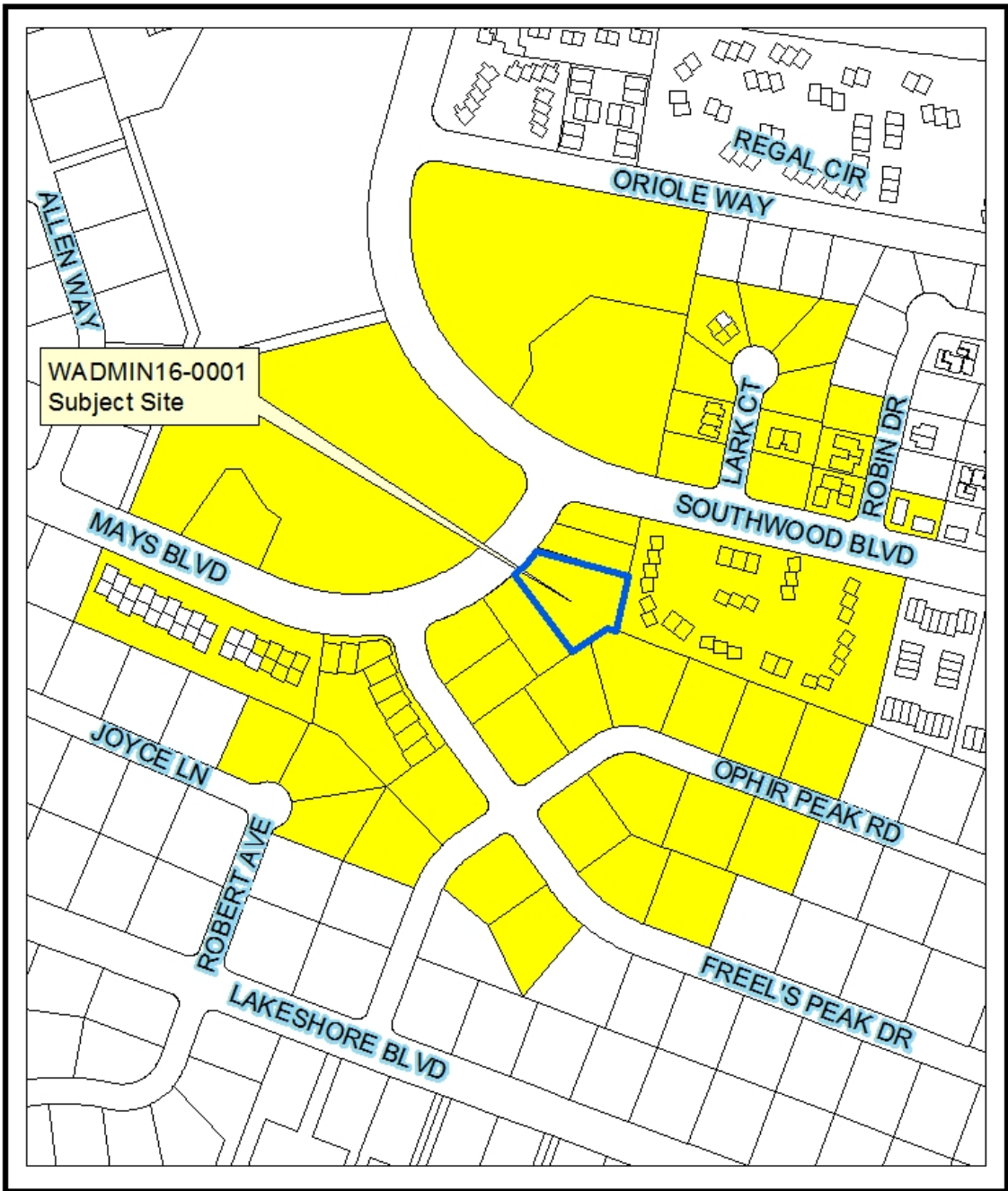

Mailing Label Map
Administrative Permit Case No WADMIN16-0001
Mays Building
 108 Parcels selected at 500 feet.



Community Services
 Department
 Planning and
 Development Division
WASHOE COUNTY
NEVADA
 Post Office Box 11120
 Reno, Nevada 89520
 (775) 328-2600

Source: Planning and Development Division

Date: December 2016

Washoe County Development Application

" ORIGINAL "

Your entire application is a public record. If you have a concern about releasing personal information, please contact Planning and Development staff at 775.328.3600.

Project Information		Staff Assigned Case No.: _____	
Project Name: Carlson & Associates			
Project Description: Mays Building			
Project Address: 795 Mays Blvd Incline Village, Nevada 89704			
Project Area (acres or square feet): 0.56 acres			
Project Location (with point of reference to major cross streets AND area locator): Southwood and Mays Blvd			
Assessor's Parcel No.(s):	Parcel Acreage:	Assessor's Parcel No.(s):	Parcel Acreage:
127-090-04	0.56		
Section(s)/Township/Range: Incline Village			
Indicate any previous Washoe County approvals associated with this application: Case No.(s). Permit Number 14-1023			
Applicant Information (attach additional sheets if necessary)			
Property Owner: Carlson & Associates		Professional Consultant:	
Name: <i>Tim Carlson</i>		Name:	
Address: 9 Silver Saddle Court Washoe Valley, NV		Address:	
Zip: 89704		Zip:	
Phone: 775-378-6563	Fax:	Phone:	Fax:
Email: <i>tc@tcarlson.biz</i>		Email:	
Cell: 775-378-6563	Other:	Cell:	Other:
Contact Person: <i>Tim Carlson</i>		Contact Person:	
Applicant/Developer:		Other Persons to be Contacted:	
Name:		Name:	
Address:		Address:	
Zip:		Zip:	
Phone:	Fax:	Phone:	Fax:
Email:		Email:	
Cell:	Other:	Cell:	Other:
Contact Person:		Contact Person:	
For Office Use Only			
Date Received:	Initial:	Planning Area:	
County Commission District:		Master Plan Designation(s):	
CAB(s):		Regulatory Zoning(s):	

Administrative Permit Application Supplemental Information

(All required information may be separately attached)

Chapter 110 of the Washoe County Code is commonly known as the Development Code. Specific references to administrative permits may be found in Article 808, Administrative Permits.

1. What is the type of project or use being requested?

Apartments

2. What currently developed portions of the property or existing structures are going to be used with this permit?

3662 sq ft. (first floor)

3. What improvements (e.g. new structures, roadway improvements, utilities, sanitation, water supply, drainage, parking, signs, etc.) will have to be constructed or installed and what is the projected time frame for the completion of each?

Tenant improvements within existing building envelope, no change to exterior pa

4. What is the intended phasing schedule for the construction and completion of the project?

Presently completed completed first phase, completion of project with this second

5. What physical characteristics of your location and/or premises are especially suited to deal with the impacts and the intensity of your proposed use?

Existing building is within residential area.

6. What are the anticipated beneficial aspects or effects your project will have on adjacent properties and the community?

Moderate income housing has been identified by the County as being needed.

7. What will you do to minimize the anticipated negative impacts or effects your project will have on adjacent properties?

Impacts are negligent as the adjacent properties are rental apartments and cond

8. Please describe operational parameters and/or voluntary conditions of approval to be imposed on the administrative permit to address community impacts.

None

9. How many improved parking spaces, both on-site and off-site, are available or will be provided? (Please indicate on site plan.)

29 parking spaces provided on site (see page A-1)

10. What types of landscaping (e.g. shrubs, trees, fencing, painting scheme, etc.) are proposed? (Please indicate location on site plan.)

No changes

11. What type of signs and lighting will be provided? On a separate sheet, show a depiction (height, width, construction materials, colors, illumination methods, lighting intensity, base landscaping, etc.) of each sign and the typical lighting standards. (Please indicate location of signs and lights on site plan.)

No changes other than handicap parking designation

Property Owner Affidavit

Applicant Name: Carlson & Associates --- Terri Carlson Owner

The receipt of this application at the time of submittal does not guarantee the application complies with all requirements of the Washoe County Development Code, the Washoe County Master Plan or the applicable area plan, the applicable regulatory zoning, or that the application is deemed complete and will be processed.

STATE OF NEVADA)
COUNTY OF WASHOE)

Terri Carlson
(please print name)

being duly sworn, depose and say that I am the owner of the property or properties involved in this application as listed below and that the foregoing statements and answers herein contained and the information herewith submitted are in all respects complete, true, and correct to the best of my knowledge and belief. I understand that no assurance or guarantee can be given by members of Planning and Development.

(A separate Affidavit must be provided by each property owner named in the title report.)

Assessor Parcel Number(s): 127-090-04

Printed Name Terri Carlson

Signed [Signature]

Address 9 SILVER SADDLE COURT
WASHOE VALLEY, NV 89704

Subscribed and sworn to before me this 12 day of December, 2016.

Regina Joines
Notary Public in and for said county and state
My commission expires: 4/20/2019

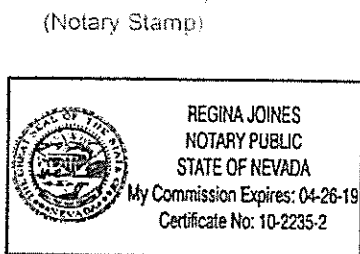

*Owner refers to the following: (Please mark appropriate box.)

- Owner
- Corporate Officer/Partner (Provide copy of record document indicating authority to sign.)
- Power of Attorney (Provide copy of Power of Attorney.)
- Owner Agent (Provide notarized letter from property owner giving legal authority to agent.)
- Property Agent (Provide copy of record document indicating authority to sign.)
- Letter from Government Agency with Stewardship

Washoe County Treasurer
Tammi Davis

Washoe County Treasurer
P.O. Box 30039, Reno, NV 89520-3039
ph (775) 320-2510 fax (775) 320-2500
Email tax@washoecounty.us

Bill Detail

[Back to Account Detail](#) [Change of Address](#) [Print this Page](#)

Washoe County Parcel Information

Parcel ID	Status	Last Update
12700004	Active	12/13/2016 2:09:51 AM
Current Owner: CARLSON & ASSOCIATES LTD FTSP 2 SILVER SADDLE CT SILVER VALLEY, NV 89734		
Taxing District: 5200		
Legal Description: Section 16 SubdivisionName _UNSPECIFIED Lot Block Range 18 Township 16		

Installments

Period	Due Date	Tax Year	Tax	Penalty/Fee	Interest	Total Due
INST 1	8/15/2016	2016	\$0.00	\$0.00	\$0.00	\$0.00
INST 2	10/3/2016	2016	\$0.00	\$0.00	\$0.00	\$0.00
INST 3	1/2/2017	2016	\$2,063.63	\$0.00	\$0.00	\$2,063.63
INST 4	3/6/2017	2016	\$2,063.63	\$0.00	\$0.00	\$2,063.63
Total Due:			\$4,127.26	\$0.00	\$0.00	\$4,127.26

Tax Detail

	Gross Tax	Credit	Net Tax
Incline_Recreati	\$1,560.00	\$0.00	\$1,560.00
Incline_Village	\$725.16	\$0.00	\$725.16
North_Lake_Tahoe_2	\$1,203.30	\$0.00	\$1,203.30
State of Nevada	\$725.16	\$0.00	\$725.16
Washoe_County	\$2,661.95	\$0.00	\$2,661.95
Washoe_County_Sc	\$2,177.65	\$0.00	\$2,177.65
LAKE TAHOE WATER BASIN	\$0.20	\$0.00	\$0.20
Total Tax	\$8,254.54	\$0.00	\$8,254.54

Payment History

Tax Year	Bill Number	Receipt Number	Amount Paid	Last Paid
2016	2016101502	816120427	\$2,063.64	10/11/2016
2016	2016101503	816120460	\$2,063.64	11/29/2016

The Washoe County Treasurer's Office makes every effort to produce and publish the most current and accurate information possible. No warranties, expressed or implied, are provided for the data herein. If you have any questions, please contact us at (775) 320-2510 or tax@washoecounty.us

This site is best viewed using Google Chrome, Internet Explorer 11, Mozilla Firefox or Safari

Pay By Check

Please make checks payable to:

WASHOE COUNTY
TREASURER

Mailing Address:
P.O. Box 30039
Reno, NV 89520-3039

Overnight Address:
1001 E. Ninth St., Ste D140
Reno, NV 89512-2645

Change of Address

All requests for a mailing address change must be submitted in writing, including a signature (unless using the online form).

To submit your address change online click here

Address change requests may also be faxed to: (775) 320-2500

Address change requests may also be mailed to: Washoe County Treasurer
P.O. Box 30039
Reno, NV 89520-3039

Washoe County Treasurer
Tammi Davis

Washoe County Treasurer
P.O. Box 30039, Reno, NV 89520-0039
ph (775) 328-2510 fax: (775) 328-2500
Email: tax@washoecounty.us

Bill Detail

[Back to Account Detail](#)

[Change of Address](#)

[Print this Page](#)

Pay By Check

Washoe County Parcel Information

Parcel ID	Status	Last Update
12709004	Active	12/13/2016 2:09:51 AM
Current Owner: CARLSON & ASSOCIATES LTD PTSP 9 SILVER SHADOW CT WASHOE VALLEY, NV 89754		
Taxing District: 5200		
Site ID:		

Please make checks payable to:
**WASHOE COUNTY
TREASURER**

Mailing Address:
P.O. Box 30039
Reno, NV 89520-3039

Overnight Address:
1001 E. Ninth St., Ste D140
Reno, NV 89512-1045

Legal Description

Section 16 Subdivision Name: UNSPECIFIED Lot Block Range 18 Township 16

Installments

Period	Due Date	Tax Year	Tax	Penalty/Fee	Interest	Total Due
INST 1	6/15/2016	2016	\$0.00	\$0.00	\$0.00	\$0.00
INST 2	10/1/2016	2016	\$0.00	\$0.20	\$0.00	\$0.20
INST 3	1/2/2017	2016	\$2,063.63	\$0.00	\$0.00	\$2,063.63
INST 4	1/6/2017	2016	\$2,063.63	\$0.00	\$0.00	\$2,063.63
Total Due:			\$4,127.26	\$0.00	\$0.00	\$4,127.26

Change of Address

All requests for a mailing address change must be submitted in writing, including a signature (unless using the online form).

To submit your address change online [click here](#)

Address change requests may also be faxed to: (775) 328-2500

Address change requests may also mailed to: Washoe County Treasurer
P.O. Box 30039
Reno, NV 89520-3039

Tax Detail

	Gross Tax	Credit	Net Tax
Incline Recreati	\$1,660.00	\$0.00	\$1,660.00
Incline Village	\$325.16	\$0.00	\$325.16
North Lake Tahoe 2	\$1,203.30	\$0.00	\$1,203.30
State of Nevada	\$325.16	\$0.00	\$325.16
Washoe County	\$2,661.95	\$0.00	\$2,661.95
Washoe County SG	\$2,177.65	\$0.00	\$2,177.65
LAKE TAHOE WATER BASIN	\$0.20	\$0.00	\$0.20
Total Tax	\$8,254.54	\$0.00	\$8,254.54

Payment History

Tax Year	Bill Number	Receipt Number	Amount Paid	Last Paid
2016	2016101500	81431987	\$2,063.64	10/11/2016
2016	2016101500	81522460	\$2,063.64	7/29/2016

The Washoe County Treasurer's Office makes every effort to produce and publish the most current and accurate information possible. No warranties, expressed or implied, are provided for the data herein, its use or its interpretation. If you have any questions, please contact us at (775) 328-2510 or tax@washoecounty.us

This site is best viewed using Google Chrome, Internet Explorer 11, Mozilla Firefox or Safari.



© 1991 THE DUBÉ GROUP, INC.
THIS DOCUMENT IS THE PROPERTY OF THE ARCHITECT AND IS TO BE USED ONLY FOR THE PROJECT AND SITE SPECIFICALLY IDENTIFIED HEREIN. IT IS NOT TO BE REPRODUCED, COPIED, EITHER WHOLLY OR IN PART, OR TRANSMITTED IN ANY FORM OR BY ANY MEANS, ELECTRONIC OR MECHANICAL, INCLUDING PHOTOCOPYING, RECORDING, OR BY ANY INFORMATION STORAGE AND RETRIEVAL SYSTEM, WITHOUT THE WRITTEN PERMISSION OF THE ARCHITECT. THE ARCHITECT'S LIABILITY IS LIMITED TO THE PROFESSIONAL SERVICES PROVIDED BY THE ARCHITECT AND DOES NOT INCLUDE THE DESIGN OF STRUCTURES, MECHANICAL, ELECTRICAL, OR PLUMBING SYSTEMS, OR THE CONSTRUCTION OF SUCH SYSTEMS. THE ARCHITECT IS NOT RESPONSIBLE FOR THE DESIGN OR CONSTRUCTION OF SUCH SYSTEMS OR FOR THE SAFETY OF SUCH SYSTEMS OR FOR THE SAFETY OF THE PROJECT OR SITE.

PROJECT TITLE:
PHASE 2
FIRST FLOOR TENANT IMPROVEMENTS
APARTMENTS & OFFICE

JOB NUMBER: 15-1107
DATE: 1/22/2018
DRAWN BY: ARL MS
CHECKED BY: FRD
REVISIONS:

SHEET DESCRIPTION:
GENERAL NOTES

SHEET NUMBER:
A0.1

SYMBOL LEGEND

DOOR SYMBOL: DOOR NUMBER

ROOM LINE SYMBOL: ROOM NAME

ENTRY: ROOM NUMBER

WALL TYPE SYMBOL: WALL TYPE

SHEET JOINT SYMBOL: KEYNOTE NUMBER

EXTERIOR ELEVATION SYMBOL: ELEVATION NUMBER

INTERIOR ELEVATION SYMBOL: ELEVATION NUMBER

DETAIL SYMBOL: DETAIL NUMBER

SECTION SYMBOL: SECTION NUMBER

WHEN MORE THAN ONE BLOCK IS USED FOR A SECTION, THE NUMBER OF THE LOWEST NUMBERED BLOCK IS USED. THUS NUMBERS ARE SHOWN IN THE FOLLOWING DIAGRAM.

12	9	6	3
11	8	5	2
10	7	4	1

DETAIL NUMBERING

THE NUMBERING SYSTEM USED FOR DETAILS ON THE DRAWINGS IS AS SHOWN IN THE FOLLOWING DIAGRAM.

- GENERAL NOTES**
- CONTRACTOR SHALL VERIFY THAT (E) CONDITIONS ARE AS INDICATED ON THE DRAWINGS. NOTIFY ARCHITECT IMMEDIATELY OF VARIATIONS OR DISCREPANCIES. DO NOT PROCEED WITH AFFECTED WORK UNTIL THE VARIATIONS OR DISCREPANCIES ARE RESOLVED BY THE ARCHITECT.
 - ALL CONSTRUCTION AND INSTALLATION WORK SHOWN ON DRAWINGS SHALL BE DONE IN ACCORDANCE WITH ALL APPLICABLE CODES AND ORDINANCES. USE METHODS AS REQUIRED TO COMPLETE WORK WITHIN LIMITATIONS OF ALL PREVAILING LAWS AND CODES.
 - DO NOT SCALE DRAWINGS; USE DIMENSIONS SHOWN. ALL DIMENSIONS SHALL BE VERIFIED IN THE FIELD. DIMENSIONS SHOWN AT (E) CONDITIONS ARE TO CENTER OF STUD UNLESS OTHERWISE NOTED. U.O.N. DIMENSIONS AT NEW WORK ARE TO FACE OF FRAMING, U.O.N. DIMENSIONS OF EXISTING WORK ARE TO FACE OF FRAMING. ALL DIMENSIONS SHALL BE VERIFIED BY CONTRACTOR IN THE FIELD. DIMENSIONS AND DIMENSIONS PROVIDED. CONSULT WITH THE ARCHITECT FOR CLARIFICATION BEFORE PROCEEDING WITH AFFECTED WORK.
 - SAFETY MEASURES: AT ALL TIMES THE CONTRACTOR SHALL BE SOLELY RESPONSIBLE FOR THE CONDITIONS AT THE JOB SITE, INCLUDING SAFETY OF PEOPLE AND PROPERTY. ARCHITECT SITE VISITS ARE NOT INTENDED TO REVIEW THE ADEQUACY OF THE CONTRACTOR'S SAFETY MEASURES AND INSTALL MANUFACTURED MATERIALS AND EQUIPMENT PER MANUFACTURER'S RECOMMENDATIONS AND INSTRUCTIONS, UNLESS OTHERWISE INSTRUCTED.
 - ALL WASTE AND REFUSE CAUSED IN CONNECTION WITH THE WORK SHALL BE REMOVED FROM THE PREMISES AND DISPOSED OF BY THE CONTRACTOR. THE PREMISES SHALL BE LEFT CLEAR AND CLEAN TO THE SATISFACTION OF THE ARCHITECT.
 - APPLICATION OF FINISH: SURFACES PREVIOUSLY PREPARED OR INSTALLED BY ANOTHER TRADE SHALL BE INSPECTED CAREFULLY BY THE CONTRACTOR BEFORE APPLYING SUBSEQUENT MATERIALS. THE CONTRACTOR SHALL BE RESPONSIBLE FOR THE PROTECTION OF ALL FINISHES. CORRECTIONS IN ORDER THAT CORRECTIONS MAY BE MADE. APPLICATIONS OF FINISHES WILL BE CONSIDERED AS ACCEPTANCE OF RESPONSIBILITY BY THE SUBCONTRACTOR FOR THE BASE UPON WHICH IT IS APPLIED.
 - INSTALL ALL WORK PLUMB, LEVEL AND STRAIGHT, OR AS REQUIRED TO ALIGN WITH (E) ADJACENT SURFACES.
 - CONTRACTOR SHALL DESIGN AND INSTALL SHORING AS REQUIRED TO REFORM WORK. RESPONSIBILITY FOR ENGINEERING, CONSTRUCTION, AND SAFETY OF THE SHORING SHALL BE THE RESPONSIBILITY OF THE CONTRACTOR.
 - REFER TO SPECIFICATIONS FOR ADDITIONAL INFORMATION. THE DRAWINGS AND SPECIFICATIONS ARE INTENDED TO BE COMPLEMENTARY. CONFLICTS BETWEEN VARIOUS ELEMENTS OF THE DRAWINGS, SPECIFICATIONS, NOTES AND DETAILS SHALL BE BROUGHT TO THE ATTENTION OF THE ARCHITECT AND RESOLVED BEFORE PROCEEDING WITH WORK.
 - DETAILS SHOWN SHALL BE INCORPORATED INTO THE PROJECT AT ALL APPROPRIATE LOCATIONS WHETHER SPECIFICALLY CALLED OUT OR NOT.
 - THE CONTRACTOR MUST SUBMIT IN WRITING ANY REQUESTS FOR MODIFICATIONS TO THE PLANS AND SPECIFICATIONS. SHOP DRAWINGS SUBMITTED TO THE ARCHITECT FOR REVIEW DO NOT CONSTITUTE "IN WRITING" UNLESS IT IS CLEARLY NOTED ON THE SUBMITTAL THAT SPECIFIC CHANGES ARE BEING REQUESTED WITH THE PHRASE "REQUESTED CHANGE".
 - FINAL AS-BUILT RECORD DOCUMENTS SHOWING ALL REVISIONS INCORPORATED DURING CONSTRUCTION SHALL BE SUBMITTED TO THE ARCHITECT PRIOR TO PROJECT CLOSE-OUT.
 - THROUGHOUT THE CONSTRUCTION DOCUMENTS, ITEMS THAT ARE EXISTING ARE INDICATED AS "EXISTING" OR "E.X." ITEMS THAT REQUIRE CONSTRUCTION ARE NEW CONSTRUCTION. WHERE REQUIRED FOR PURPOSES OF CLARITY, SOME ITEMS MAY BE INDICATED AS "NEW OR (N)".
- HAZARDOUS MATERIALS**
- DUBÉ GROUP ARCHITECTURE ASSUMES NO RESPONSIBILITY FOR THE MANAGEMENT OF HAZARDOUS MATERIALS THAT MAY BE ON THIS SITE. AN INVESTIGATION FOR HAZARDOUS MATERIALS HAS BEEN PERFORMED BY PEZONELLA ASSOCIATES, INC. THE RESULTING REPORT DATED MARCH 6, 2014 IS AVAILABLE UPON REQUEST FROM THE OWNER.
 - THE CONTRACTOR SHALL BE RESPONSIBLE FOR INSURING WITHIN THE WORK AREA ARE PROTECTED FROM EXPOSURE TO ANY HAZARDOUS MATERIALS ENCOUNTERED. IF MATERIALS ARE DISCOVERED THAT MAY BE HAZARDOUS, THE CONTRACTOR SHALL IMMEDIATELY NOTIFY THE ARCHITECT AND STOP WORK UNTIL CONDITIONS CAN BE MAINTAINED IN COMPLIANCE WITH ALL APPLICABLE REGULATIONS.

NOTE: FULL SETS ARE 34"X28" HALF SIZE SETS ARE 12"X18" CONFORM SCALES SHOWN ON DRAWINGS



DESIGNED BY: [NAME]
DATE: [DATE]
PROJECT: [PROJECT NAME]
DRAWN BY: [NAME]
CHECKED BY: [NAME]
REVISIONS:

PROJECT TITLE:
FIRST FLOOR TENANT IMPROVEMENTS
APARTMENTS & OFFICE

DATE: 12/20/18
DRAWN BY: ASL, MS
CHECKED BY: PRO
REVISIONS:

SHEET DESCRIPTION:
ADA DETAILS

SHEET NUMBER:
A0.2

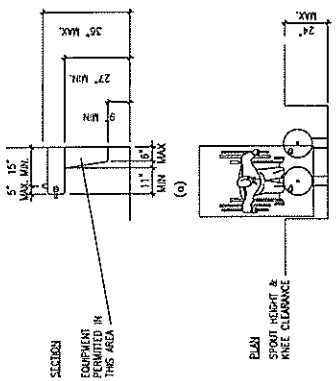
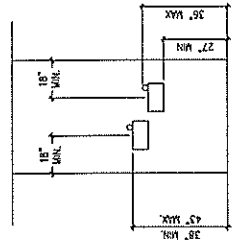

2 DRINKING FOUNTAIN DETAILS
SCALE: 1/2" = 1'-0"

NOTE 1: THE FORCE REQUIRED TO ACTIVATE WATER CLOSET AND URINAL FLUSH CONTROLS AND FAUCET AND OPERATING MECHANISM CONTROLS SHALL BE NO GREATER THAN 5 LB.

NOTE 2: WATER CLOSET AND URINAL FLUSH VALVE CONTROLS, AND FAUCET OPERATING MECHANISM CONTROLS SHALL BE OPERABLE WITH ONE HAND, AND SHALL BE MOUNTED NO MORE THAN 44" ABOVE THE FLOOR.

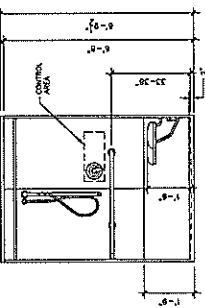

6 ADA MOUNTING HEIGHTS
SCALE: 1/2" = 1'-0"

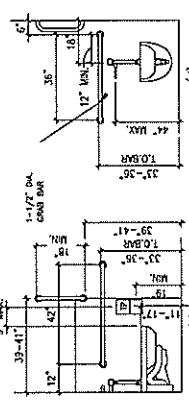

7 FLOOR MOUNTED - FRONT
8 FLOOR MOUNTED - SIDE
SCALE: 1/2" = 1'-0"

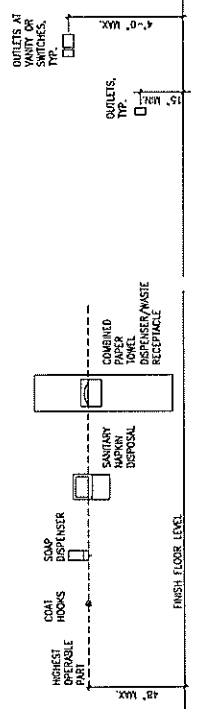

TOILET ROOM ACCESSORIES

4 TOILET ACCESSORIES MOUNTING SCHEDULE
SCALE: 1/2" = 1'-0"

NOTE 1: THE FORCE REQUIRED TO ACTIVATE WATER CLOSET AND URINAL FLUSH CONTROLS AND FAUCET AND OPERATING MECHANISM CONTROLS SHALL BE NO GREATER THAN 5 LB.

NOTE 2: WATER CLOSET AND URINAL FLUSH VALVE CONTROLS, AND FAUCET OPERATING MECHANISM CONTROLS SHALL BE OPERABLE WITH ONE HAND, SHALL NOT REQUIRE TIGHT GRASPING, PINCHING OR POWER GRASPING, AND SHALL BE MOUNTED NO MORE THAN 44" ABOVE THE FLOOR.

5 OUTLET MOUNTING SCHEDULE
SCALE: 1/2" = 1'-0"

NOTE: SELF-CLOSING FAUCETS AND FAUCETS WITH A HANDLE OR LEAST TO SECONDARY.

NOTE: HOT WATER AND DRAIN PIPES SHALL BE ISOLATED OR OTHERWISE COVERED. THESE SHALL BE NO UNDER LANDINGS.

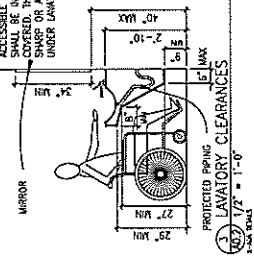

3 LAVATORY CLEARANCES
SCALE: 1/2" = 1'-0"

5 URINAL CLEARANCES
SCALE: 1/2" = 1'-0"

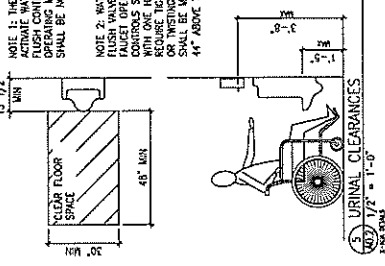

NOTE: FULL SETS ARE 24"x36" HALF SETS ARE 12"x36" CONFORM SCALES SHOWN ON DRAWINGS



THIS IS A PRELIMINARY DRAWING. IT IS THE USER'S RESPONSIBILITY TO VERIFY ALL INFORMATION AND CONDITIONS. THE USER SHALL BE RESPONSIBLE FOR OBTAINING ALL NECESSARY PERMITS AND APPROVALS. THE USER SHALL BE RESPONSIBLE FOR OBTAINING ALL NECESSARY PERMITS AND APPROVALS. THE USER SHALL BE RESPONSIBLE FOR OBTAINING ALL NECESSARY PERMITS AND APPROVALS.

PROJECT TITLE:
FIRST FLOOR TOWHAT IMPROVEMENTS
APARTMENTS & OFFICE

JOB NUMBER: 15-110
DATE: 11/25/2016
DRAWN BY: ASL, JRS
CHECKED BY: PRO
APPROVED BY:

SHEET DESCRIPTION:
ADA DETAILS

SHEET NUMBER:
A0.3

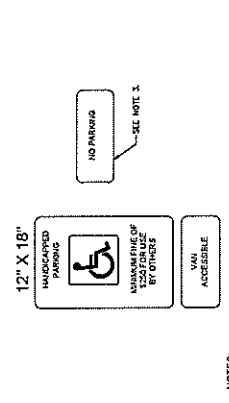

- NOTES:**
- SIGN SHALL BE MOUNTED NO LESS THAN 7 FEET ABOVE GROUND. PROVIDE SIGN POST AND FOUNDATION PER SUPPLY 12-415. SIGN TO BE MOUNTED ON THE OUTSIDE OF PARKING STALL.
 - TEXT TO BE IN BLACK ON WHITE BACKGROUND.
 - PROVIDE NO PARKING SIGN AND SIGN POST AND FOUNDATION PER SUPPLY 12-415.
 - PROVIDE VAN ACCESSIBLE PARKING STALLS BETWEEN ACCESSIBLE PARKING STALLS. PER PLAN.
 - PROVIDE VAN-RESISTANT HARDWARE.

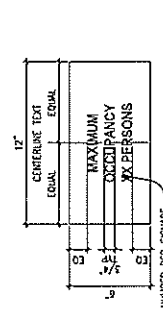

- NOTES:**
- 1/4" PAINTED PHOTOCHROMIC SIGN ATTACHED TO WALL WITH DOUBLE-SIDED TAPES. WORK 1/4" DIA. EASED EDGES AND CORNERS, TYP.
 - LETTERS, BRILLE AND PICTORIAL SYMBOLS 1/32" MIN. USE SANS GLASS FINISH. COLOR TO BE SELECTED FROM MANUFACTURER'S STANDARD RANGE.
 - USE CHALK, 3 BRILLE.

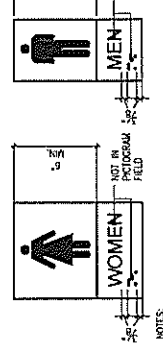
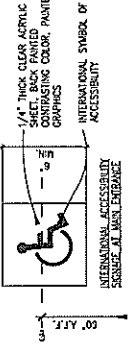

- NOTES:**
- 1/4" PAINTED PHOTOCHROMIC SIGN ATTACHED TO WALL WITH DOUBLE-SIDED TAPES. WORK 1/4" DIA. EASED EDGES AND CORNERS, TYP.
 - LETTERS, BRILLE AND PICTORIAL SYMBOLS 1/32" MIN. USE SANS GLASS FINISH. COLOR TO BE SELECTED FROM MANUFACTURER'S STANDARD RANGE.
 - USE CHALK, 3 BRILLE.

5. SIGNAGE DETAILS
SCALE: NTS

HARDWARE OPERABLE FROM THE INSIDE WITHOUT THE USE OF A KEY OR TOOL. PROVIDE AN OPERABLE EFFORT OF 5 LBS. MAXIMUM EFFORT TO OPERATE EXTERIOR DOORS, 5 LBS. FOR INTERIOR DOORS.

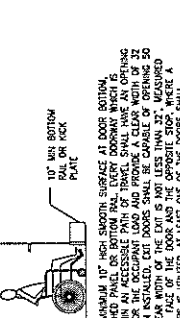

DOOR REQUIREMENTS
SCALE: NTS

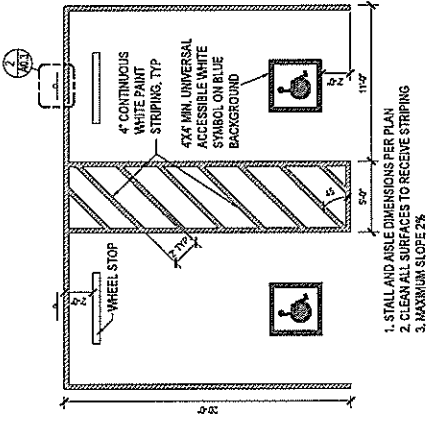

5. STALL & AISLE DIMENSION DETAIL
SCALE: 1/4" = 1'-0"

- STALL AND AISLE DIMENSIONS PER PLAN
- CLEAN ALL SURFACES TO RECEIVE STRIPING
- MAXIMUM SLOPE 2%

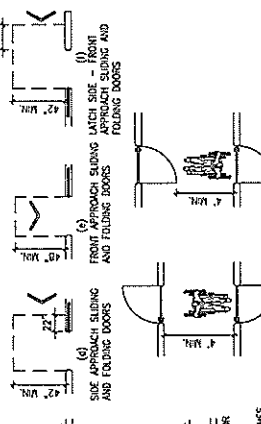

DOOR APPROACHES
SCALE: 1/4" = 1'-0"

NOTE:

- ALL DOORS IN ALCOVES SHALL COMPLY WITH THE CLEARANCES FOR FRONT APPROACHES.
- THERE SHALL BE A LEVEL FLOOR OR LANDING ON EACH SIDE OF THE DOOR.

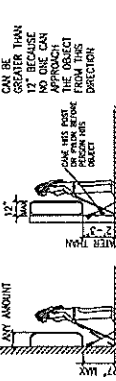
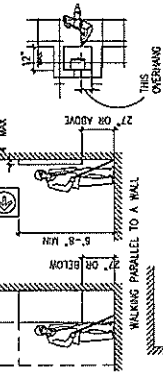
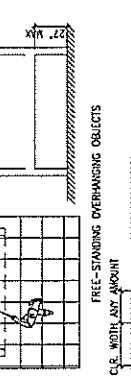

5. VISUAL IMPAIRED DETAILS
SCALE: 1/4" = 1'-0"

- 12" MIN. IF DOOR HAS BOTH LATCH AND CLOSER
- 12" MIN. IF DOOR HAS CLOSER
- 12" MIN. IF DOOR HAS LATCH

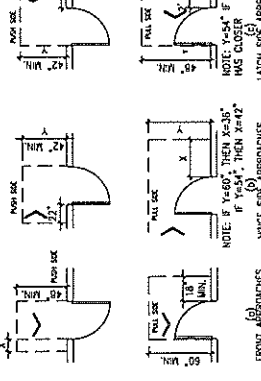

DOOR APPROACHES
SCALE: 1/4" = 1'-0"

NOTE:

- IF Y=48", THEN X=36"
- IF Y=54", THEN X=42"
- IF Y=60", THEN X=48"
- IF Y=66", THEN X=54"
- IF Y=72", THEN X=60"
- IF Y=78", THEN X=66"
- IF Y=84", THEN X=72"
- IF Y=90", THEN X=78"
- IF Y=96", THEN X=84"
- IF Y=102", THEN X=90"
- IF Y=108", THEN X=96"
- IF Y=114", THEN X=102"
- IF Y=120", THEN X=108"
- IF Y=126", THEN X=114"
- IF Y=132", THEN X=120"
- IF Y=138", THEN X=126"
- IF Y=144", THEN X=132"
- IF Y=150", THEN X=138"
- IF Y=156", THEN X=144"
- IF Y=162", THEN X=150"
- IF Y=168", THEN X=156"
- IF Y=174", THEN X=162"
- IF Y=180", THEN X=168"
- IF Y=186", THEN X=174"
- IF Y=192", THEN X=180"
- IF Y=198", THEN X=186"
- IF Y=204", THEN X=192"
- IF Y=210", THEN X=198"
- IF Y=216", THEN X=204"
- IF Y=222", THEN X=210"
- IF Y=228", THEN X=216"
- IF Y=234", THEN X=222"
- IF Y=240", THEN X=228"
- IF Y=246", THEN X=234"
- IF Y=252", THEN X=240"
- IF Y=258", THEN X=246"
- IF Y=264", THEN X=252"
- IF Y=270", THEN X=258"
- IF Y=276", THEN X=264"
- IF Y=282", THEN X=270"
- IF Y=288", THEN X=276"
- IF Y=294", THEN X=282"
- IF Y=300", THEN X=288"
- IF Y=306", THEN X=294"
- IF Y=312", THEN X=300"
- IF Y=318", THEN X=306"
- IF Y=324", THEN X=312"
- IF Y=330", THEN X=318"
- IF Y=336", THEN X=324"
- IF Y=342", THEN X=330"
- IF Y=348", THEN X=336"
- IF Y=354", THEN X=342"
- IF Y=360", THEN X=348"
- IF Y=366", THEN X=354"
- IF Y=372", THEN X=360"
- IF Y=378", THEN X=366"
- IF Y=384", THEN X=372"
- IF Y=390", THEN X=378"
- IF Y=396", THEN X=384"
- IF Y=402", THEN X=390"
- IF Y=408", THEN X=396"
- IF Y=414", THEN X=402"
- IF Y=420", THEN X=408"
- IF Y=426", THEN X=414"
- IF Y=432", THEN X=420"
- IF Y=438", THEN X=426"
- IF Y=444", THEN X=432"
- IF Y=450", THEN X=438"
- IF Y=456", THEN X=444"
- IF Y=462", THEN X=450"
- IF Y=468", THEN X=456"
- IF Y=474", THEN X=462"
- IF Y=480", THEN X=468"
- IF Y=486", THEN X=474"
- IF Y=492", THEN X=480"
- IF Y=498", THEN X=486"
- IF Y=504", THEN X=492"
- IF Y=510", THEN X=498"
- IF Y=516", THEN X=504"
- IF Y=522", THEN X=510"
- IF Y=528", THEN X=516"
- IF Y=534", THEN X=522"
- IF Y=540", THEN X=528"
- IF Y=546", THEN X=534"
- IF Y=552", THEN X=540"
- IF Y=558", THEN X=546"
- IF Y=564", THEN X=552"
- IF Y=570", THEN X=558"
- IF Y=576", THEN X=564"
- IF Y=582", THEN X=570"
- IF Y=588", THEN X=576"
- IF Y=594", THEN X=582"
- IF Y=600", THEN X=588"
- IF Y=606", THEN X=594"
- IF Y=612", THEN X=600"
- IF Y=618", THEN X=606"
- IF Y=624", THEN X=612"
- IF Y=630", THEN X=618"
- IF Y=636", THEN X=624"
- IF Y=642", THEN X=630"
- IF Y=648", THEN X=636"
- IF Y=654", THEN X=642"
- IF Y=660", THEN X=648"
- IF Y=666", THEN X=654"
- IF Y=672", THEN X=660"
- IF Y=678", THEN X=666"
- IF Y=684", THEN X=672"
- IF Y=690", THEN X=678"
- IF Y=696", THEN X=684"
- IF Y=702", THEN X=690"
- IF Y=708", THEN X=696"
- IF Y=714", THEN X=702"
- IF Y=720", THEN X=708"
- IF Y=726", THEN X=714"
- IF Y=732", THEN X=720"
- IF Y=738", THEN X=726"
- IF Y=744", THEN X=732"
- IF Y=750", THEN X=738"
- IF Y=756", THEN X=744"
- IF Y=762", THEN X=750"
- IF Y=768", THEN X=756"
- IF Y=774", THEN X=762"
- IF Y=780", THEN X=768"
- IF Y=786", THEN X=774"
- IF Y=792", THEN X=780"
- IF Y=798", THEN X=786"
- IF Y=804", THEN X=792"
- IF Y=810", THEN X=798"
- IF Y=816", THEN X=804"
- IF Y=822", THEN X=810"
- IF Y=828", THEN X=816"
- IF Y=834", THEN X=822"
- IF Y=840", THEN X=828"
- IF Y=846", THEN X=834"
- IF Y=852", THEN X=840"
- IF Y=858", THEN X=846"
- IF Y=864", THEN X=852"
- IF Y=870", THEN X=858"
- IF Y=876", THEN X=864"
- IF Y=882", THEN X=870"
- IF Y=888", THEN X=876"
- IF Y=894", THEN X=882"
- IF Y=900", THEN X=888"
- IF Y=906", THEN X=894"
- IF Y=912", THEN X=900"
- IF Y=918", THEN X=906"
- IF Y=924", THEN X=912"
- IF Y=930", THEN X=918"
- IF Y=936", THEN X=924"
- IF Y=942", THEN X=930"
- IF Y=948", THEN X=936"
- IF Y=954", THEN X=942"
- IF Y=960", THEN X=948"
- IF Y=966", THEN X=954"
- IF Y=972", THEN X=960"
- IF Y=978", THEN X=966"
- IF Y=984", THEN X=972"
- IF Y=990", THEN X=978"
- IF Y=996", THEN X=984"
- IF Y=1002", THEN X=990"
- IF Y=1008", THEN X=996"
- IF Y=1014", THEN X=1002"
- IF Y=1020", THEN X=1008"
- IF Y=1026", THEN X=1014"
- IF Y=1032", THEN X=1020"
- IF Y=1038", THEN X=1026"
- IF Y=1044", THEN X=1032"
- IF Y=1050", THEN X=1038"
- IF Y=1056", THEN X=1044"
- IF Y=1062", THEN X=1050"
- IF Y=1068", THEN X=1056"
- IF Y=1074", THEN X=1062"
- IF Y=1080", THEN X=1068"
- IF Y=1086", THEN X=1074"
- IF Y=1092", THEN X=1080"
- IF Y=1098", THEN X=1086"
- IF Y=1104", THEN X=1092"
- IF Y=1110", THEN X=1098"
- IF Y=1116", THEN X=1104"
- IF Y=1122", THEN X=1110"
- IF Y=1128", THEN X=1116"
- IF Y=1134", THEN X=1122"
- IF Y=1140", THEN X=1128"
- IF Y=1146", THEN X=1134"
- IF Y=1152", THEN X=1140"
- IF Y=1158", THEN X=1146"
- IF Y=1164", THEN X=1152"
- IF Y=1170", THEN X=1158"
- IF Y=1176", THEN X=1164"
- IF Y=1182", THEN X=1170"
- IF Y=1188", THEN X=1176"
- IF Y=1194", THEN X=1182"
- IF Y=1200", THEN X=1188"
- IF Y=1206", THEN X=1194"
- IF Y=1212", THEN X=1200"
- IF Y=1218", THEN X=1206"
- IF Y=1224", THEN X=1212"
- IF Y=1230", THEN X=1218"
- IF Y=1236", THEN X=1224"
- IF Y=1242", THEN X=1230"
- IF Y=1248", THEN X=1236"
- IF Y=1254", THEN X=1242"
- IF Y=1260", THEN X=1248"
- IF Y=1266", THEN X=1254"
- IF Y=1272", THEN X=1260"
- IF Y=1278", THEN X=1266"
- IF Y=1284", THEN X=1272"
- IF Y=1290", THEN X=1278"
- IF Y=1296", THEN X=1284"
- IF Y=1302", THEN X=1290"
- IF Y=1308", THEN X=1296"
- IF Y=1314", THEN X=1302"
- IF Y=1320", THEN X=1308"
- IF Y=1326", THEN X=1314"
- IF Y=1332", THEN X=1320"
- IF Y=1338", THEN X=1326"
- IF Y=1344", THEN X=1332"
- IF Y=1350", THEN X=1338"
- IF Y=1356", THEN X=1344"
- IF Y=1362", THEN X=1350"
- IF Y=1368", THEN X=1356"
- IF Y=1374", THEN X=1362"
- IF Y=1380", THEN X=1368"
- IF Y=1386", THEN X=1374"
- IF Y=1392", THEN X=1380"
- IF Y=1398", THEN X=1386"
- IF Y=1404", THEN X=1392"
- IF Y=1410", THEN X=1398"
- IF Y=1416", THEN X=1404"
- IF Y=1422", THEN X=1410"
- IF Y=1428", THEN X=1416"
- IF Y=1434", THEN X=1422"
- IF Y=1440", THEN X=1428"
- IF Y=1446", THEN X=1434"
- IF Y=1452", THEN X=1440"
- IF Y=1458", THEN X=1446"
- IF Y=1464", THEN X=1452"
- IF Y=1470", THEN X=1458"
- IF Y=1476", THEN X=1464"
- IF Y=1482", THEN X=1470"
- IF Y=1488", THEN X=1476"
- IF Y=1494", THEN X=1482"
- IF Y=1500", THEN X=1488"
- IF Y=1506", THEN X=1494"
- IF Y=1512", THEN X=1500"
- IF Y=1518", THEN X=1506"
- IF Y=1524", THEN X=1512"
- IF Y=1530", THEN X=1518"
- IF Y=1536", THEN X=1524"
- IF Y=1542", THEN X=1530"
- IF Y=1548", THEN X=1536"
- IF Y=1554", THEN X=1542"
- IF Y=1560", THEN X=1548"
- IF Y=1566", THEN X=1554"
- IF Y=1572", THEN X=1560"
- IF Y=1578", THEN X=1566"
- IF Y=1584", THEN X=1572"
- IF Y=1590", THEN X=1578"
- IF Y=1596", THEN X=1584"
- IF Y=1602", THEN X=1590"
- IF Y=1608", THEN X=1596"
- IF Y=1614", THEN X=1602"
- IF Y=1620", THEN X=1608"
- IF Y=1626", THEN X=1614"
- IF Y=1632", THEN X=1620"
- IF Y=1638", THEN X=1626"
- IF Y=1644", THEN X=1632"
- IF Y=1650", THEN X=1638"
- IF Y=1656", THEN X=1644"
- IF Y=1662", THEN X=1650"
- IF Y=1668", THEN X=1656"
- IF Y=1674", THEN X=1662"
- IF Y=1680", THEN X=1668"
- IF Y=1686", THEN X=1674"
- IF Y=1692", THEN X=1680"
- IF Y=1698", THEN X=1686"
- IF Y=1704", THEN X=1692"
- IF Y=1710", THEN X=1698"
- IF Y=1716", THEN X=1704"
- IF Y=1722", THEN X=1710"
- IF Y=1728", THEN X=1716"
- IF Y=1734", THEN X=1722"
- IF Y=1740", THEN X=1728"
- IF Y=1746", THEN X=1734"
- IF Y=1752", THEN X=1740"
- IF Y=1758", THEN X=1746"
- IF Y=1764", THEN X=1752"
- IF Y=1770", THEN X=1758"
- IF Y=1776", THEN X=1764"
- IF Y=1782", THEN X=1770"
- IF Y=1788", THEN X=1776"
- IF Y=1794", THEN X=1782"
- IF Y=1800", THEN X=1788"
- IF Y=1806", THEN X=1794"
- IF Y=1812", THEN X=1800"
- IF Y=1818", THEN X=1806"
- IF Y=1824", THEN X=1812"
- IF Y=1830", THEN X=1818"
- IF Y=1836", THEN X=1824"
- IF Y=1842", THEN X=1830"
- IF Y=1848", THEN X=1836"
- IF Y=1854", THEN X=1842"
- IF Y=1860", THEN X=1848"
- IF Y=1866", THEN X=1854"
- IF Y=1872", THEN X=1860"
- IF Y=1878", THEN X=1866"
- IF Y=1884", THEN X=1872"
- IF Y=1890", THEN X=1878"
- IF Y=1896", THEN X=1884"
- IF Y=1902", THEN X=1890"
- IF Y=1908", THEN X=1896"
- IF Y=1914", THEN X=1902"
- IF Y=1920", THEN X=1908"
- IF Y=1926", THEN X=1914"
- IF Y=1932", THEN X=1920"
- IF Y=1938", THEN X=1926"
- IF Y=1944", THEN X=1932"
- IF Y=1950", THEN X=1938"
- IF Y=1956", THEN X=1944"
- IF Y=1962", THEN X=1950"
- IF Y=1968", THEN X=1956"
- IF Y=1974", THEN X=1962"
- IF Y=1980", THEN X=1968"
- IF Y=1986", THEN X=1974"
- IF Y=1992", THEN X=1980"
- IF Y=1998", THEN X=1986"
- IF Y=2004", THEN X=1992"
- IF Y=2010", THEN X=1998"
- IF Y=2016", THEN X=2004"
- IF Y=2022", THEN X=2010"
- IF Y=2028", THEN X=2016"
- IF Y=2034", THEN X=2022"
- IF Y=2040", THEN X=2028"
- IF Y=2046", THEN X=2034"
- IF Y=2052", THEN X=2040"
- IF Y=2058", THEN X=2046"
- IF Y=2064", THEN X=2052"
- IF Y=2070", THEN X=2058"
- IF Y=2076", THEN X=2064"
- IF Y=2082", THEN X=2070"
- IF Y=2088", THEN X=2076"
- IF Y=2094", THEN X=2082"
- IF Y=2100", THEN X=2088"
- IF Y=2106", THEN X=2094"
- IF Y=2112", THEN X=2100"
- IF Y=2118", THEN X=2106"
- IF Y=2124", THEN X=2112"
- IF Y=2130", THEN X=2118"
- IF Y=2136", THEN X=2124"
- IF Y=2142", THEN X=2130"
- IF Y=2148", THEN X=2136"
- IF Y=2154", THEN X=2142"
- IF Y=2160", THEN X=2148"
- IF Y=2166", THEN X=2154"
- IF Y=2172", THEN X=2160"
- IF Y=2178", THEN X=2166"
- IF Y=2184", THEN X=2172"
- IF Y=2190", THEN X=2178"
- IF Y=2196", THEN X=2184"
- IF Y=2202", THEN X=2190"
- IF Y=2208", THEN X=2196"
- IF Y=2214", THEN X=2202"
- IF Y=2220", THEN X=2208"
- IF Y=2226", THEN X=2214"
- IF Y=2232", THEN X=2220"
- IF Y=2238", THEN X=2226"
- IF Y=2244", THEN X=2232"
- IF Y=2250", THEN X=2238"
- IF Y=2256", THEN X=2244"
- IF Y=2262", THEN X=2250"
- IF Y=2268", THEN X=2256"
- IF Y=2274", THEN X=2262"
- IF Y=2280", THEN X=2268"
- IF Y=2286", THEN X=2274"
- IF Y=2292", THEN X=2280"
- IF Y=2298", THEN X=2286"
- IF Y=2304", THEN X=2292"
- IF Y=2310", THEN X=2298"
- IF Y=2316", THEN X=2304"
- IF Y=2322", THEN X=2310"
- IF Y=2328", THEN X=2316"
- IF Y=2334", THEN X=2322"
- IF Y=2340", THEN X=2328"
- IF Y=2346", THEN X=2334"
- IF Y=2352", THEN X=2340"
- IF Y=2358", THEN X=2346"
- IF Y=2364", THEN X=2352"
- IF Y=2370", THEN X=2358"
- IF Y=2376", THEN X=2364"
- IF Y=2382", THEN X=2370"
- IF Y=2388", THEN X=2376"
- IF Y=2394", THEN X=2382"
- IF Y=2400", THEN X=2388"
- IF Y=2406", THEN X=2394"
- IF Y=2412", THEN X=2400"
- IF Y=2418", THEN X=2406"
- IF Y=2424", THEN X=2412"
- IF Y=2430", THEN X=2418"
- IF Y=2436", THEN X=2424"
- IF Y=2442", THEN X=2430"
- IF Y=2448", THEN X=2436"
- IF Y=2454", THEN X=2442"
- IF Y=2460", THEN X=2448"
- IF Y=2466", THEN X=2454"
- IF Y=2472", THEN X=2460"
- IF Y=2478", THEN X=2466"
- IF Y=2484", THEN X=2472"
- IF Y=2490", THEN X=2478"
- IF Y=2496", THEN X=2484"
- IF Y=2502", THEN X=2490"
- IF Y=2508", THEN X=2496"
- IF Y=2514", THEN X=2502"
- IF Y=2520", THEN X=2508"
- IF Y=2526", THEN X=2514"
- IF Y=2532", THEN X=2520"
- IF Y=2538", THEN X=2526"
- IF Y=2544", THEN X=2532"
- IF Y=2550", THEN X=2538"
- IF Y=2556", THEN X=2544"
- IF Y=2562", THEN X=2550"
- IF Y=2568", THEN X=2556"
- IF Y=2574", THEN X=2562"
- IF Y=2580", THEN X=2568"
- IF Y=2586", THEN X=2574"
- IF Y=2592", THEN X=2580"
- IF Y=2598", THEN X=2586"
- IF Y=2604", THEN X=2592"
- IF Y=2610", THEN X=2598"
- IF Y=2616", THEN X=2604"
- IF Y=2622", THEN X=2610"
- IF Y=2628", THEN X=2616"
- IF Y=2634", THEN X=2622"
- IF Y=2640", THEN X=2628"
- IF Y=2646", THEN X=2634"
- IF Y=2652", THEN X=2640"
- IF Y=2658", THEN X=2646"
- IF Y=2664", THEN X=2652"
- IF Y=2670", THEN X=2658"
- IF Y=2676", THEN X=2664"
- IF Y=2682", THEN X=2670"
- IF Y=2688", THEN X=2676"
- IF Y=2694", THEN X=2682"
- IF Y=2700", THEN X=2688"
- IF Y=2706", THEN X=2694"
- IF Y=2712", THEN X=2700"
- IF Y=2718", THEN X=2706"
- IF Y=2724", THEN X=2712"
- IF Y=2730", THEN X=2718"
- IF Y=2736", THEN X=2724"
- IF Y=2742", THEN X=2730"
- IF Y=2748", THEN X=2736"
- IF Y=2754", THEN X=2742"
- IF Y=2760", THEN X=2748"
- IF Y=2766", THEN X=2754"
- IF Y=2772", THEN X=2760"
- IF Y=2778", THEN X=2766"
- IF Y=2784", THEN X=2772"
- IF Y=2790", THEN X=2778"
- IF Y=2796", THEN X=2784"
- IF Y=2802", THEN X=2790"
- IF Y=2808", THEN X=2796"
- IF Y=2814", THEN X=2802"
- IF Y=2820", THEN X=2808"
- IF Y=2826", THEN X=2814"
- IF Y=2832", THEN X=2820"
- IF Y=2838", THEN X=2826"
- IF Y=2844", THEN X=2832"
- IF Y=2850", THEN X=2838"
- IF Y=2856", THEN X=2844"
- IF Y=2862", THEN X=2850"
- IF Y=2868", THEN X=2856"
- IF Y=2874", THEN X=2862"
- IF Y=2880", THEN X=2868"
- IF Y=2886", THEN X=2874"
- IF Y=2892", THEN X=2880"
- IF Y=2898", THEN X=2886"
- IF Y=2904", THEN X=2892"
- IF Y=2910", THEN X=2898"
- IF Y=2916", THEN X=2904"
- IF Y=2922", THEN X=2910"
- IF Y=2928", THEN X=2916"
- IF Y=2934", THEN X=2922"
- IF Y=2940", THEN X=2928"
- IF Y=2946", THEN X=2934"
- IF Y=2952", THEN X=2940"



© 2015 by Dubé Group, Inc.
NO PART OF THIS DOCUMENT IS TO BE REPRODUCED OR TRANSMITTED IN ANY FORM OR BY ANY MEANS, ELECTRONIC OR MECHANICAL, INCLUDING PHOTOCOPYING, RECORDING, OR BY ANY INFORMATION STORAGE AND RETRIEVAL SYSTEM, WITHOUT THE WRITTEN PERMISSION OF THE ARCHITECT. THIS DOCUMENT IS THE PROPERTY OF THE ARCHITECT AND IS TO BE USED ONLY FOR THE PROJECT AND SITE SPECIFICALLY IDENTIFIED HEREIN. IT IS NOT TO BE USED FOR ANY OTHER PROJECT OR SITE WITHOUT THE WRITTEN PERMISSION OF THE ARCHITECT. THE ARCHITECT ASSUMES NO LIABILITY FOR ANY ERRORS OR OMISSIONS IN THIS DOCUMENT. THE ARCHITECT'S LIABILITY IS LIMITED TO THE PROFESSIONAL SERVICES PROVIDED BY THE ARCHITECT.

PROJECT TITLE:
PHASE 2 -
PARK FACILITY TENANT IMPROVEMENTS
APARTMENTS & OFFICE

JOB NUMBER: 16-1129
DATE: 11/20/15
DRAWN BY: ARL MS
CHECKED BY: PRD
REVISIONS:

SHEET DESCRIPTION:
SITE PLAN

SHEET NUMBER:
A1.0

- BASEMENT**
3395 TOTAL SQUARE FEET
3170 PARKING GARAGES
425 STORAGE
- APARTMENTS & OFFICE**
3662 TOTAL SQUARE FEET
OFFICE- 539
4PENTHOUS= 2 SPACE REQUIRED
2BEDROOM= 21 SPACES REQUIRED
1BEDROOM= 16 SPACE REQUIRED
1BEDROOM= 16 SPACE REQUIRED
1BEDROOM= 16 SPACE REQUIRED
- FLOOR 2A3: EXISTING APARTMENTS**
5742 TOTAL SQUARE FEET
UNIT 5- 677 SQ.FT.
UNIT 6- 5755SQ=1665
UNIT 7- 686
UNIT 8- 6026SQ= 1226
UNIT 9- 514
UNIT 10- 6062SQ= 1227
HALLWAY= 347
- 1 BEDROOM= 16 SPACE REQUIRED
1 BEDROOM= 16 SPACE REQUIRED
1 BEDROOM= 16 SPACE REQUIRED
1 BEDROOM= 16 SPACE REQUIRED
1 BEDROOM= 16 SPACE REQUIRED
1 BEDROOM= 16 SPACE REQUIRED

SUMMARY:
19 TOTAL SPACES REQUIRED
1 SPACE ACCESSIBLE REQUIRED
16 STANDARD SPACES REQUIRED

29 TOTAL (E) SPACES PROVIDED
2 ACCESSIBLE SPACES PROVIDED
27 STANDARD SPACES PROVIDED

NOTE:
WORK DONE AT THIS PHASE IS LIMITED TO DETAIL
2-A0.3 AND 3-A0.3
PARKING SHOWN IS EXISTING AND NOT PART OF SCOPE

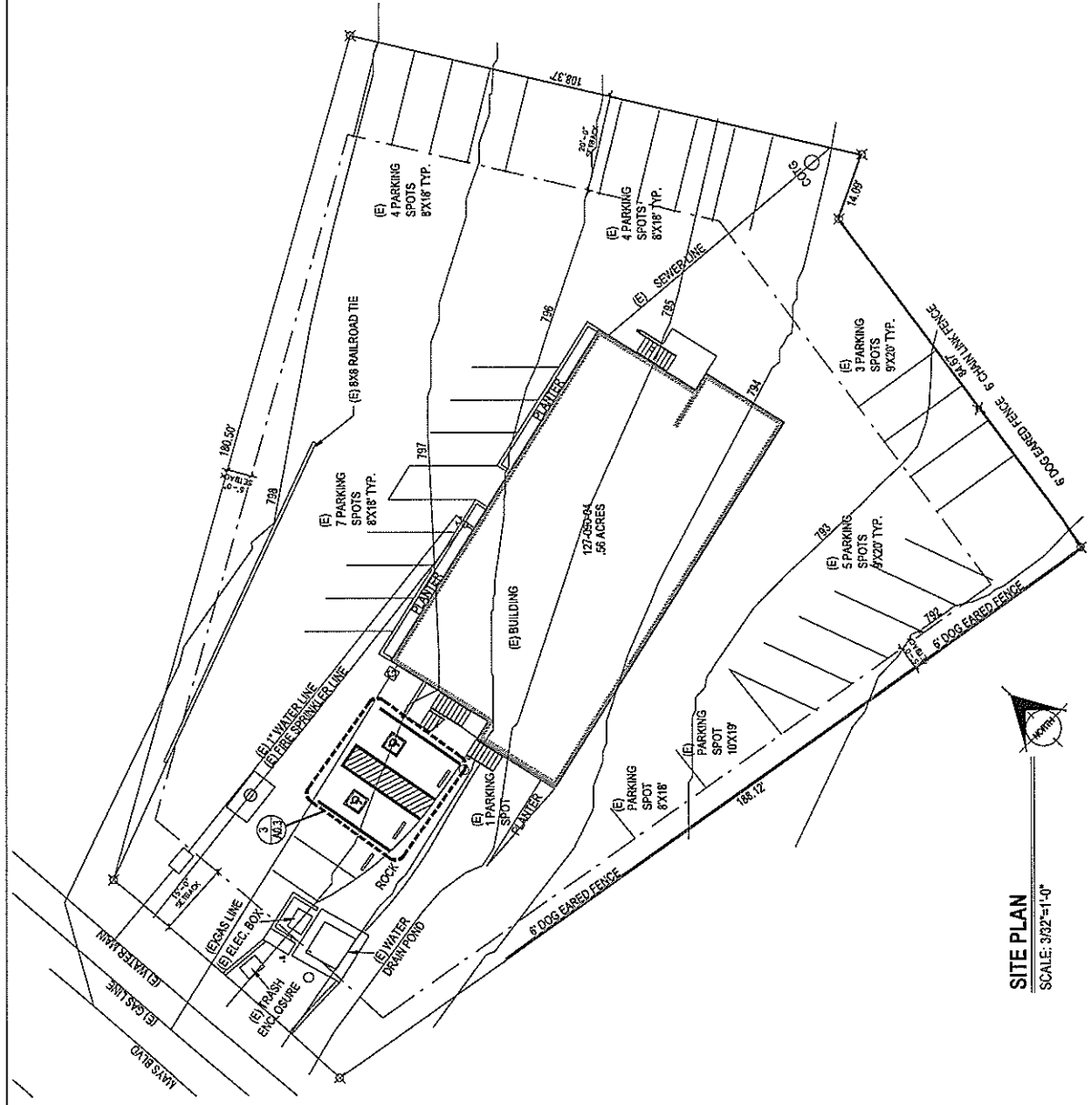

SITE PLAN
SCALE: 3/32"=1'-0"

NOTE: ALL SETS ARE 2'-0" UNLESS NOTED OTHERWISE. ALL SETS ARE 12'-0" UNLESS NOTED OTHERWISE. CONFORM SCALES SHOWN ON DRAWINGS.



© 2016 The Dubé Group, Inc.
THIS DOCUMENT IS THE PROPERTY OF THE ARCHITECT. IT IS TO BE USED ONLY FOR THE PROJECT AND SITE SPECIFICALLY IDENTIFIED HEREIN. ANY REUSE OR MODIFICATION OF THIS DOCUMENT WITHOUT THE WRITTEN CONSENT OF THE ARCHITECT IS STRICTLY PROHIBITED. THE ARCHITECT ASSUMES NO LIABILITY FOR THE ACCURACY OF THE INFORMATION PROVIDED HEREIN, NOR FOR THE CONSEQUENCES OF ANY ACTION TAKEN OR NOT TAKEN IN RELIANCE THEREON. THE USER OF THIS DOCUMENT SHALL BE RESPONSIBLE FOR OBTAINING ALL NECESSARY PERMITS AND APPROVALS FROM THE APPROPRIATE AUTHORITIES. THE ARCHITECT'S LIABILITY IS LIMITED TO THE PROFESSIONAL SERVICES PROVIDED HEREIN. THE ARCHITECT DOES NOT WARRANT THE ACCURACY OF THE INFORMATION PROVIDED HEREIN, NOR THE FITNESS OF THE INFORMATION FOR ANY PARTICULAR PURPOSE. THE ARCHITECT'S LIABILITY IS LIMITED TO THE PROFESSIONAL SERVICES PROVIDED HEREIN.

PROJECT TITLE:
FIRST FLOOR TENANT IMPROVEMENTS
APARTMENTS OFFICE

JOB NUMBER: 16-1190
DATE: 11/22/2016
DRAWN BY: ARL MS
CHECKED BY: ARL MS
REVISIONS:

SHEET DESCRIPTION:
FIRST FLOOR PLAN

SHEET NUMBER:
A1.1

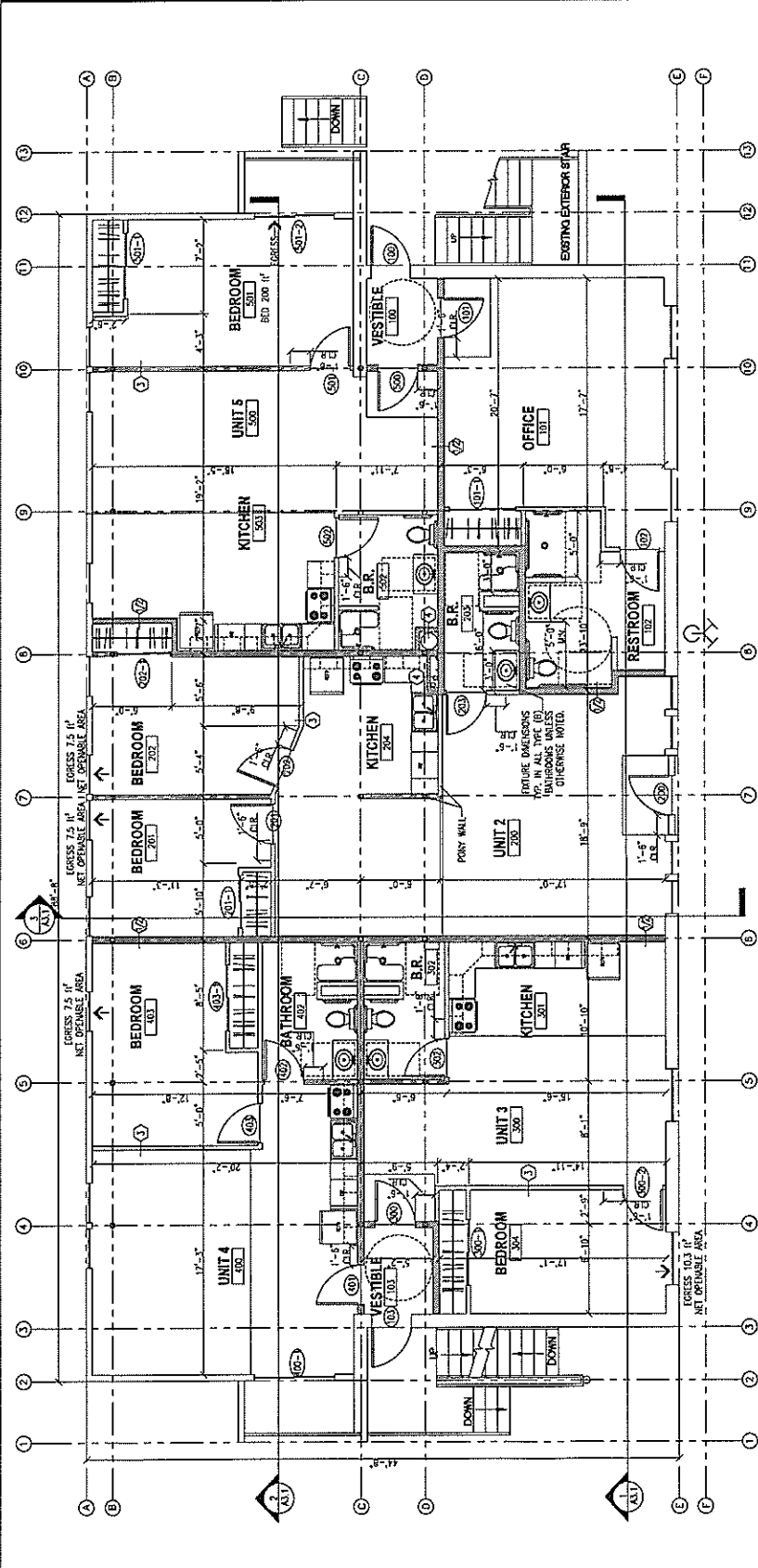

- GENERAL NOTES**
- VERIFY ALL DIMENSIONS. DIMENSIONS GIVEN ARE TO CENTER OF STUDS UNLESS OTHERWISE NOTED.
 - STUD SPACING: ALL INTERMEDIATE STUDS SHALL BE 16" O.C. WITH 1" TYPE 5 DRYWALL SCREWS @ 8" O.C. AT VERTICAL FACE LAYER 5/8" TYPE X OPSUM WALLBOARD OR OPSUM VESTER BASE WALLBOARD OR OPSUM VESTER BASE WALLBOARD TO ONE SIDE WITH 1 1/2" TYPE 5 DRYWALL SCREWS 12" O.C.
 - AMIS STAGGERED 24" O.C. LAYERS SHALL BE STAGGERED 12" FROM EACH OTHER. GLASS FRAMER FRICTION FIT IN STUD SPACE. (N-8)

- EXISTING EXTERIOR WALLS**
- EXISTING EXTERIOR WALLS TO BE REPAIRED/REPLACED IN-RING.

- NON-BATED WALL ASSEMBLY (SCREEN WALL)**
- NON-BATED WALL ASSEMBLY (SCREEN WALL) TYPICAL - ALL NON-LINE SEPARATIONS.

- CA FILE NO. 1622 (NON-COMBUSTIBLE)**
- CA FILE NO. 1622 (NON-COMBUSTIBLE) 1 HOUR FIRE / 50-54 STC SOUND TYPICAL - ALL UNIL SEPARATIONS.

- CA FILE NO. 1629 (WOOD FRAMED)**
- CA FILE NO. 1629 (WOOD FRAMED) 1 HOUR FIRE / 50-54 STC SOUND TYPICAL - ALL UNIL SEPARATIONS.

- CA FILE NO. 1652 (WOOD FRAMED)**
- CA FILE NO. 1652 (WOOD FRAMED) 1 HOUR FIRE / 50-54 STC SOUND TYPICAL - ALL UNIL SEPARATIONS.

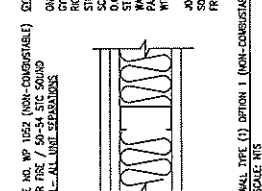
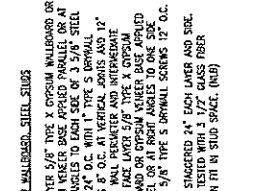
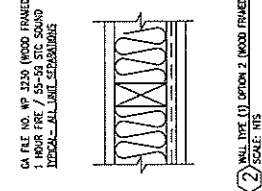
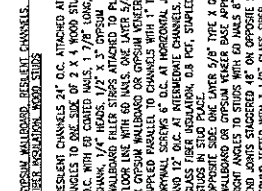
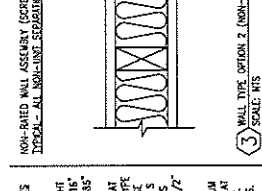
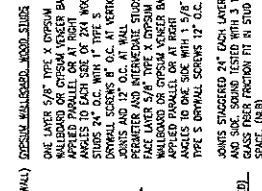
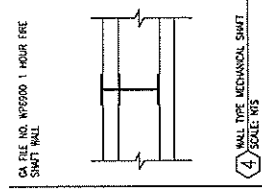
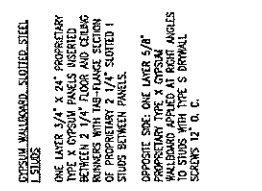



© 2018 by the Architect, A.C.
THIS DRAWING AND ALL RIGHTS HEREIN ARE RESERVED BY THE ARCHITECT. NO PART OF THIS DRAWING MAY BE REPRODUCED OR TRANSMITTED IN ANY FORM OR BY ANY MEANS, ELECTRONIC OR MECHANICAL, INCLUDING PHOTOCOPYING, RECORDING, OR BY ANY INFORMATION STORAGE AND RETRIEVAL SYSTEM, WITHOUT THE WRITTEN CONSENT OF THE ARCHITECT.
THIS DRAWING IS THE PROPERTY OF THE ARCHITECT AND IS TO BE USED ONLY FOR THE PROJECT AND SITE SPECIFICALLY IDENTIFIED HEREON. IT IS NOT TO BE USED FOR ANY OTHER PROJECT OR SITE WITHOUT THE WRITTEN CONSENT OF THE ARCHITECT.
THE ARCHITECT ASSUMES NO LIABILITY FOR THE ACCURACY OF THE INFORMATION PROVIDED BY THE CLIENT OR FOR THE CONSTRUCTION OF THE PROJECT OR FOR THE PERFORMANCE OF THE PROJECT.

PROJECT TITLE:
PHASE 2 -
FIRST FLOOR TENANT IMPROVEMENTS
APARTMENTS & OFFICE

JOB NUMBER: 16-150
DATE: 11/20/18
DRAWN BY: ASL/MS
CHECKED BY: PAB
REVISIONS:

SHEET DESCRIPTION:
UNIT 1 - FIRST FLOOR PLAN - ENLARGED

SHEET NUMBER:
A1.2

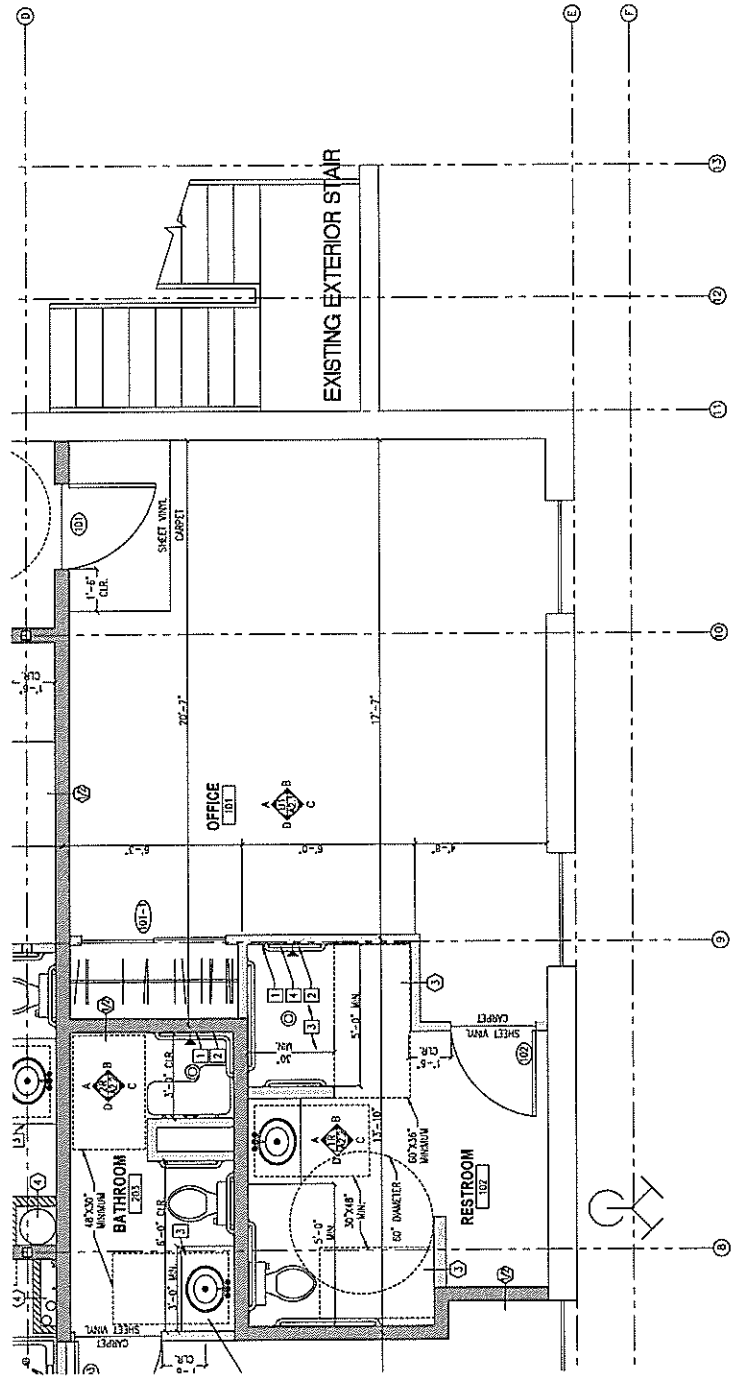

- GENERAL NOTES**
1. VERIFY ALL DIMENSIONS
 2. DIMENSIONS GIVEN ARE TO CENTER OF STUD
 3. FOR STAIRS, DIMENSIONS ARE TO FACE UNLESS OTHERWISE NOTED
 4. WALL TYPE 1 OR 2 SEE DETAIL 2-AS.1
- KEY NOTES**
1. INSTALL BASKETS FOR ADA CRAB BARS, TYP.
 2. ALL LOCATIONS SEE DETAIL 1A-S1
 3. OPERATION OF CONTROLS FOR ADA SHOW NOT TO EXCEED 48" A.F.F. ON ANY OF THE SHOWER CONTROLS
 4. MINOR DIMENSIONS OF ROLL-IN SHOWER TO BE EXACTLY 60" X 36"
 5. END OF CRAB BARS SHALL BE 6" FROM CORNERS

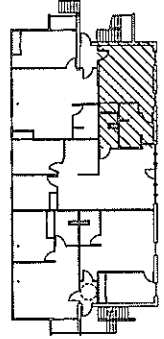

- LEGEND**
- WALL TYPES
 - TYPE 1 OR 2
 - TYPE 3
 - EXTERIOR WALLS
 - EXTERIOR WALLS - HR RATED SHWT
 - WALL TYPES
 - TYPE 1 OR 2
 - TYPE 3
 - EXTERIOR WALLS
 - EXTERIOR WALLS - HR RATED SHWT
 - ASSEMBLIES ON SHEET A1.1

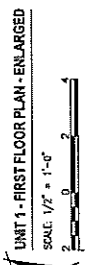

UNIT 1 - FIRST FLOOR PLAN - ENLARGED
SCALE: 1/2" = 1'-0"

NOTE: FULL SETS ARE 24"x36" HALF SETS ARE 17"x18" CONTENT SCALES SHOWN ON DRAWINGS



© 2014 by the Dubé Group, Inc.
THIS DOCUMENT IS THE PROPERTY OF DUBÉ GROUP, INC. AND IS TO BE USED ONLY FOR THE PROJECT AND SITE SPECIFICALLY IDENTIFIED HEREIN. NO PART OF THIS DOCUMENT IS TO BE REPRODUCED, STORED IN A RETRIEVING SYSTEM, TRANSMITTED IN ANY FORM OR BY ANY MEANS, ELECTRONIC OR MECHANICAL, INCLUDING PHOTOCOPYING, RECORDING, OR BY ANY INFORMATION STORAGE AND RETRIEVAL SYSTEM, WITHOUT THE WRITTEN PERMISSION OF DUBÉ GROUP, INC. THE USER OF THIS DOCUMENT IS TO BE RESPONSIBLE FOR OBTAINING ALL NECESSARY PERMITS AND APPROVALS FROM THE APPROPRIATE AGENCIES AND AUTHORITIES. THE USER OF THIS DOCUMENT IS TO BE RESPONSIBLE FOR OBTAINING ALL NECESSARY PERMITS AND APPROVALS FROM THE APPROPRIATE AGENCIES AND AUTHORITIES. THE USER OF THIS DOCUMENT IS TO BE RESPONSIBLE FOR OBTAINING ALL NECESSARY PERMITS AND APPROVALS FROM THE APPROPRIATE AGENCIES AND AUTHORITIES.

PROJECT TITLE
PHASE 2
FIRST FLOOR TRAIL APARTMENTS
APARTMENTS & OFFICE

JOB NUMBER: 16-100
DATE: 1/25/2015
DRAWN BY: ABL/MS
CHECKED BY: FPD
REVISIONS:

SHEET DESCRIPTION:
UNIT 2 FIRST FLOOR PLAN
- PARTIAL ENLARGED

SHEET NUMBER
A1.3

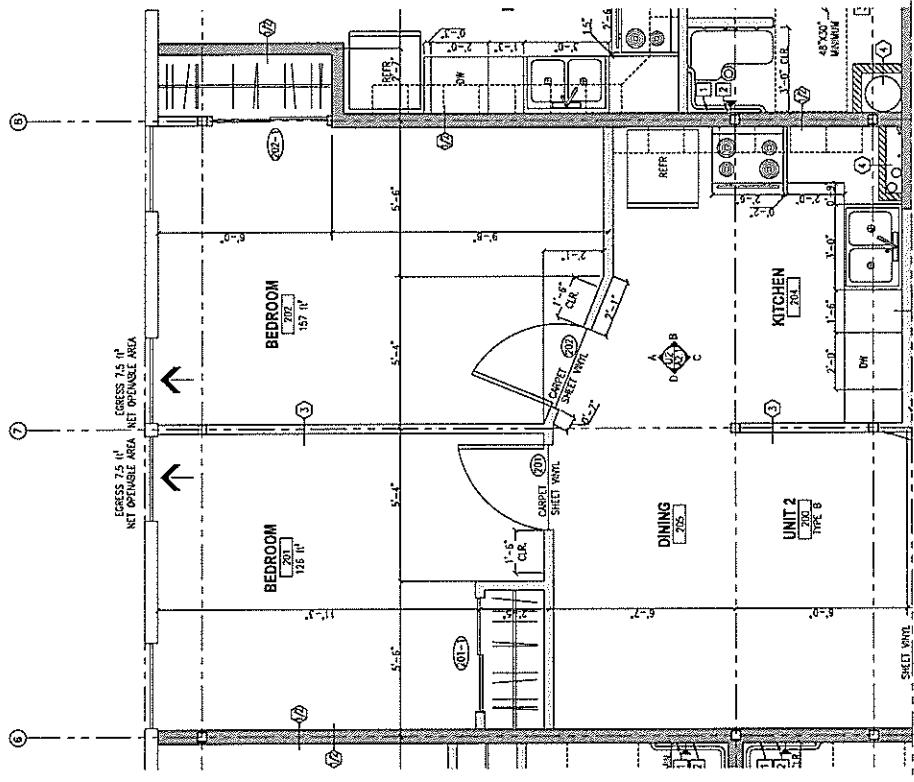

- GENERAL NOTES**
1. SEE SHEET A1.4 FOR OTHER HALF OF UNIT 2
 2. VERIFY ALL DIMENSIONS
 3. DIMENSIONS GIVEN ARE TO CENTER OF STUD
 4. FOR STOPPING ANY PENETRATIONS THROUGH WALL TYPE 1 OR 2 SEE DETAIL 2-A1.1

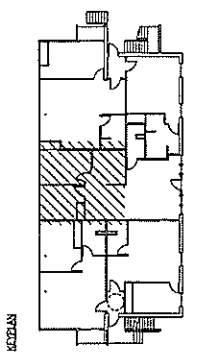

SECTION

- WALL LEGEND**
- TYPE 1 OR 2
 - TYPE 3
 - (A) EXTERIOR WALLS - 1HR RATED SHWT
- SEE WALLS ON ASSEMBLES ON SHEET A1.1

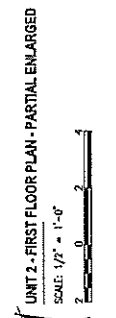

WALLLINE
SEE SHEET A1.4

NOTE: FULL SETS ARE 7'x10' UNIT SIZE SETS ARE 12'x18' CONFORM SCALES SHOWN ON DRAWINGS



© 2011 by Dubé Group, LLC.
THIS DRAWING AND ALL INFORMATION CONTAINED HEREIN ARE THE PROPERTY OF DUBÉ GROUP, LLC. NO PART OF THIS DRAWING OR INFORMATION CONTAINED HEREIN IS TO BE REPRODUCED OR TRANSMITTED IN ANY FORM OR BY ANY MEANS, ELECTRONIC OR MECHANICAL, INCLUDING PHOTOCOPYING, RECORDING, OR BY ANY INFORMATION STORAGE AND RETRIEVAL SYSTEM, WITHOUT THE WRITTEN PERMISSION OF DUBÉ GROUP, LLC. THE INFORMATION CONTAINED HEREIN IS FOR THE EXCLUSIVE USE OF THE CLIENT AND IS NOT TO BE USED FOR ANY OTHER PROJECT OR FOR ANY OTHER PURPOSE. THE CLIENT AGREES TO HOLD DUBÉ GROUP, LLC HARMLESS FROM AND AGAINST ALL CLAIMS, DAMAGES, LOSSES AND EXPENSES, INCLUDING REASONABLE ATTORNEY'S FEES, ARISING OUT OF OR RESULTING FROM THE USE OF THIS DRAWING OR INFORMATION CONTAINED HEREIN.

PROJECT TITLE:
PHASE 2 -
FIRST FLOOR TENANT IMPROVEMENTS
APARTMENTS & OFFICE

PROGRAMMER: 16-150
DATE: 11/29/2016
DRAWN BY: ASL/JS
CHECKED BY: PSD
REVISIONS:

SHEET DESCRIPTION:
UNIT 2 - FIRST FLOOR PLAN
- PARTIAL ENLARGED

SHEET NUMBER:
A1.4

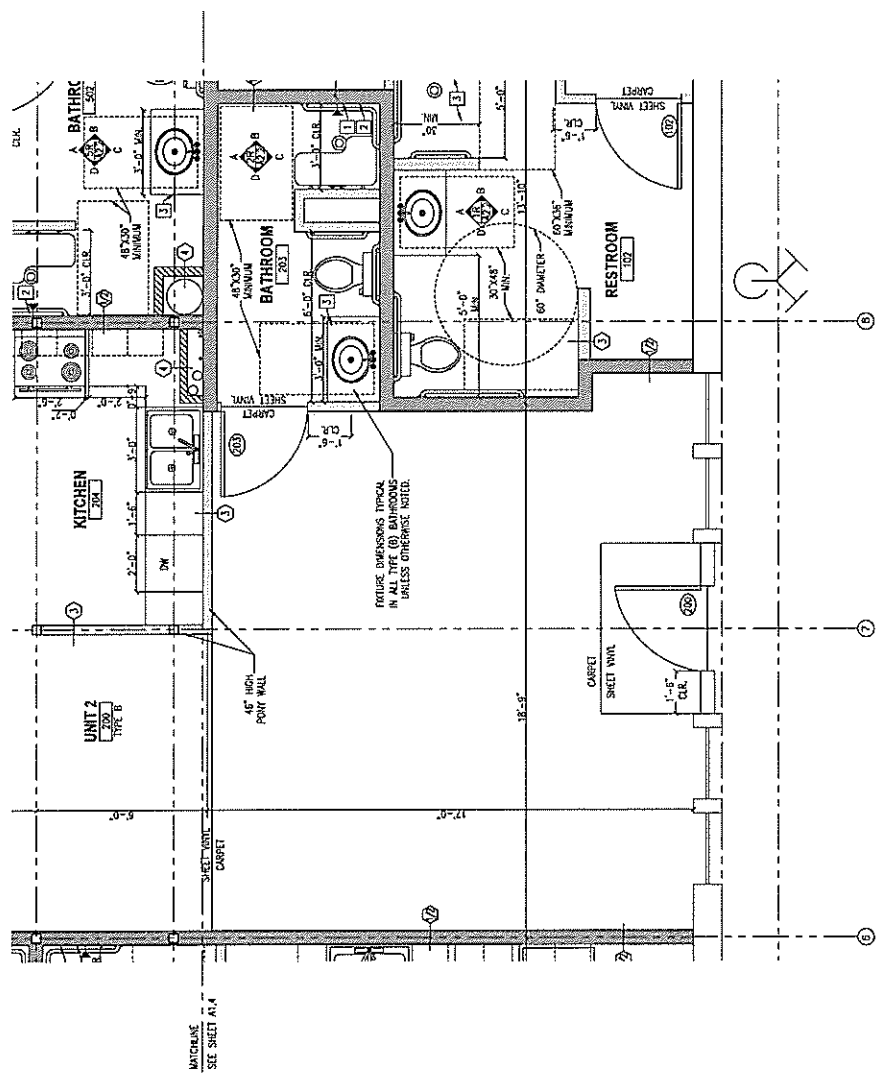

- GENERAL NOTES**
- SEE SHEET A1.3 FOR OTHER HALF OF UNIT 2
 - VERIFY ALL DIMENSIONS IN CORNER OF STUD
 - UNLESS OTHERWISE NOTED, FINISH STOPPING: ANY PENETRATIONS THROUGH FIRE STOPPING: ANY PENETRATIONS THROUGH
 - WALL TYPE 1 OR 2 SEE DETAIL 2-A5.1

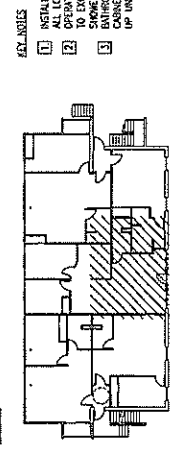

KEYNOTES

- KEYNOTES**
- NETAL FINISH FOR ALL FLOOR FINISHES, TYP. MATERIALS TO BE USED AS SHOWN. SEE DETAIL 2-A5.1
 - OPERATION OF CONTROLS FOR ADA SHOW NOT TO EXCEED 48\"/>

- WALL LEGEND**
- TYPE 1 OR 2
 - TYPE 3
 - EXTERIOR WALLS
 - IRRADIATED SHEET
- SEE WALL ASSEMBLIES ON SHEET A1.1

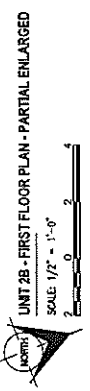

UNIT 2B - FIRST FLOOR PLAN - PARTIAL ENLARGED
SCALE: 1/2" = 1'-0"

NOTE: FULL SETS ARE 24"x36" HALF SIZE SETS ARE 12"x18" CONFORM SCALES SHOWN ON DRAWINGS



OWNER: THE STATE OF NEW YORK
 PROJECT TITLE: FIRST FLOOR TENANT IMPROVEMENTS
 APARTMENTS & OFFICE

PROJECT TITLE: FIRST FLOOR TENANT IMPROVEMENTS
 APARTMENTS & OFFICE

DATE: 1/25/2015
 DRAWN BY: ASL/MS
 CHECKED BY: PFD
 REVISIONS:

SHEET DESCRIPTION:
 UNIT 3 - FIRST FLOOR PLAN - ENLARGED

SHEET NUMBER:
A1.5

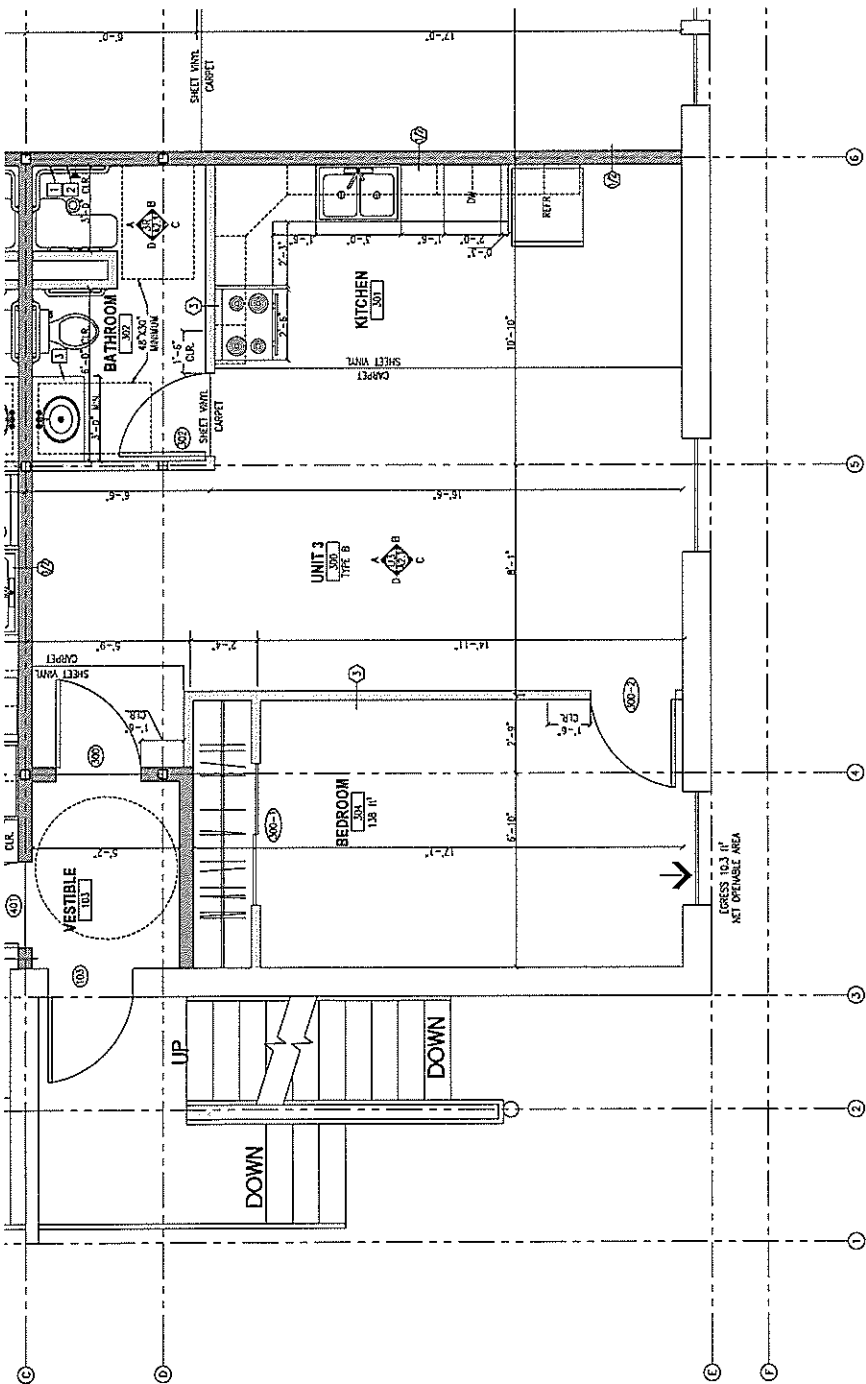

- KEY NOTES**
1. SEE SHEET A1.3 FOR OTHER PART OF UNIT 2
 2. VERIFY ALL DIMENSIONS FOR ADA COMPLIANCE
 3. DIMENSIONS GIVEN ARE TO CENTER OF STUD
 4. WALL TYPE 1 OR 2 SEE DETAIL 2-AS.1

- GENERAL NOTES**
1. INSTALL BACKERS FOR ADA GRAB BARS, TYP.
 2. ALL LOCATIONS FOR ADA COMPLIANCE
 3. OPERATION OF CONTROLS FOR ADA SHOW NOT TO EXCEED 48" A.F.T. ON ANY OF
 4. BATHROOM SINK SHALL HAVE REMOVABLE CABINET TO ALLOW A WHEELCHAIR TO ROLL UP UNDER SINK

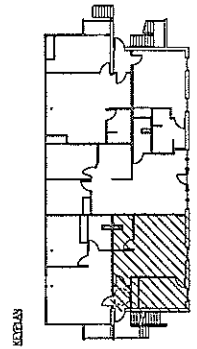

- SECTION**
- WALL/CEILING: SEE WALLS ON SHEET A1.1
 - TYPE 1 OR 2
 - TYPE 3
 - (S) EXTERIOR WALLS TYP. RATED SHIRT



UNIT 3 - FIRST FLOOR PLAN
 SCALE: 1/2" = 1'-0"

NOTE: FOL SETS ARE 24"x36" UNIT SETS ARE 12"x18" CONFORM SCALES SHOWN ON DRAWINGS



DESIGN BY THE CONSULTANT:
THE CONSULTANT SHALL BE RESPONSIBLE FOR THE ACCURACY OF THE INFORMATION PROVIDED TO THE CONTRACTOR BY THE CONSULTANT. THE CONTRACTOR SHALL BE RESPONSIBLE FOR THE ACCURACY OF THE INFORMATION PROVIDED TO THE CONTRACTOR BY THE CONTRACTOR. THE CONSULTANT SHALL NOT BE RESPONSIBLE FOR THE ACCURACY OF THE INFORMATION PROVIDED TO THE CONTRACTOR BY THE CONTRACTOR.

PROJECT TITLE:
PHASE 2:
FIRST FLOOR TENANT IMPROVEMENTS
APARTMENTS & OFFICE

JOB NUMBER: 15-1120
DATE: 1/16/2016
DRAWN BY: AEL/MS
CHECKED BY: PRD
REVISIONS:

SHEET DESCRIPTION:
UNIT 4 - FIRST FLOOR PLAN - ENLARGED

SHEET NUMBER:
A1.6

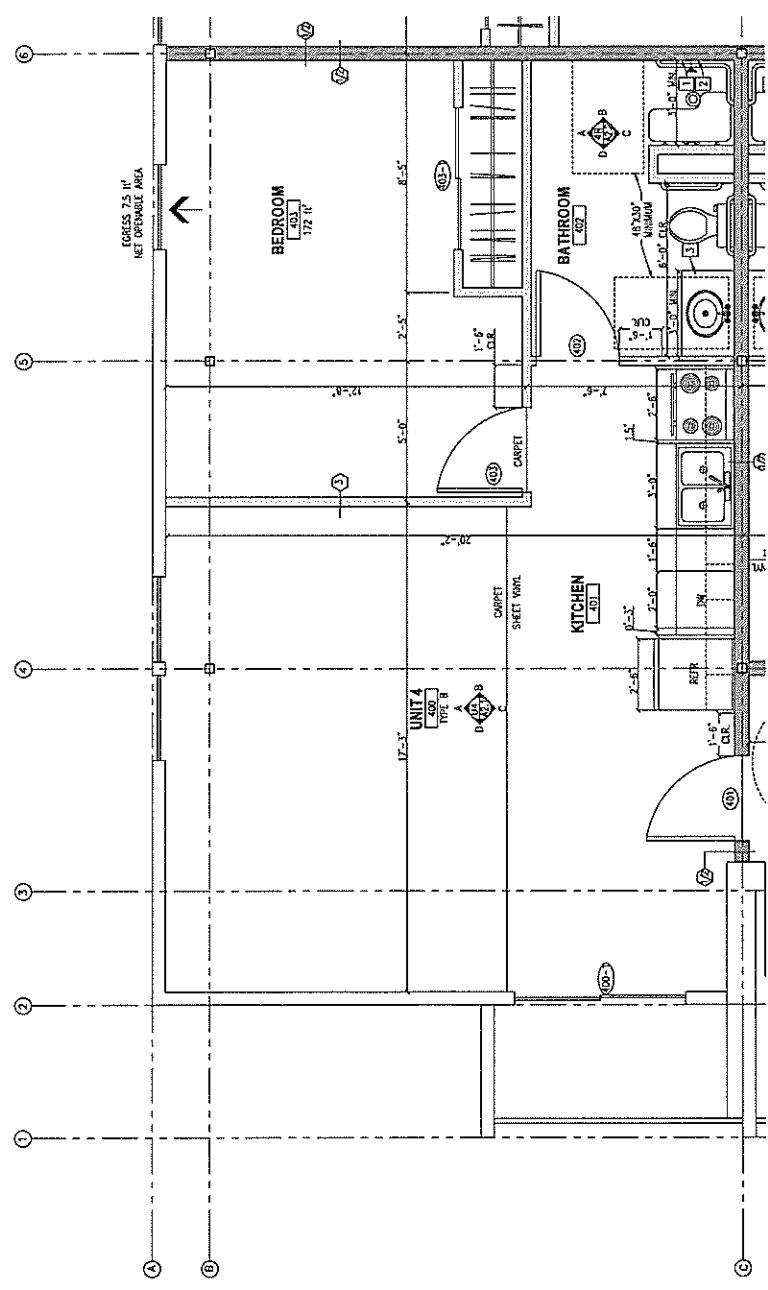

- GENERAL NOTES**
- SEE SHEET A1.3 FOR OTHER HALF OF UNIT 2
 - ALL DIMENSIONS GIVEN ARE TO CENTER OF STUD
 - UNLESS OTHERWISE NOTED
 - WALL TYPE 1 OR 2 SEE DETAIL 7-A-1
- KEY NOTES**
- INSTALL BOCKER FOR AN OAS BWS, TYP.
 - OPERATION OF COMPASS FOR AN SHW
 - NOT TO EXCEED 48" A.F.F. ON ANY OF
 - THREE SHOWER WALLS
 - SEE DETAIL 7-A-1 FOR WHEELCHAIR
 - CONCRETE TO ALLOW A WHEELCHAIR TO ROLL
 - UP UNDER SINK

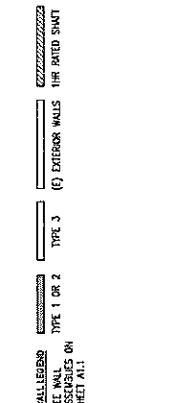
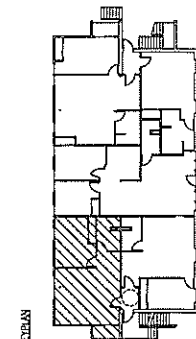
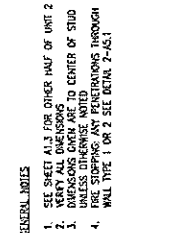

UNIT 4 - FIRST FLOOR PLAN - ENLARGED

SCALE: 1/2" = 1'-0"



NOTE: FULL SETS ARE 24"x36" HALF SIZE SETS ARE 12"x18" CONFORM SCALES SHOWN ON DRAWING



© 2017 BY THE DUBÉ GROUP, INC.
NO PART OF THIS DOCUMENT IS TO BE REPRODUCED OR TRANSMITTED IN ANY FORM OR BY ANY MEANS, ELECTRONIC OR MECHANICAL, INCLUDING PHOTOCOPYING, RECORDING, OR BY ANY INFORMATION STORAGE AND RETRIEVAL SYSTEM, WITHOUT THE WRITTEN PERMISSION OF THE ARCHITECT. THIS DOCUMENT IS THE PROPERTY OF THE ARCHITECT AND IS TO BE USED ONLY FOR THE PROJECT AND SITE SPECIFICALLY IDENTIFIED HEREIN. IT IS NOT TO BE USED FOR ANY OTHER PROJECT OR SITE WITHOUT THE WRITTEN PERMISSION OF THE ARCHITECT. THE ARCHITECT ASSUMES NO LIABILITY FOR ANY DAMAGE OR INJURY TO PERSONS OR PROPERTY, INCLUDING CONSEQUENTIAL DAMAGES, ARISING FROM THE USE OF THIS DOCUMENT, WHETHER OR NOT SUCH DAMAGE OR INJURY IS CAUSED IN WHOLE OR IN PART BY THE NEGLIGENCE OF THE ARCHITECT.

PROJECT TITLE
PHASE 2 -
FIRST FLOOR TENANT IMPROVEMENTS
APARTMENTS OFFICE

JOB NUMBER 16-110
DATE 1/16/2018
DRAWN BY: AXL MS
CHECKED BY: PRO
REVISIONS:

SHEET DESCRIPTION
REFLECTED CEILING PLAN

SHEET NUMBER
A1.8

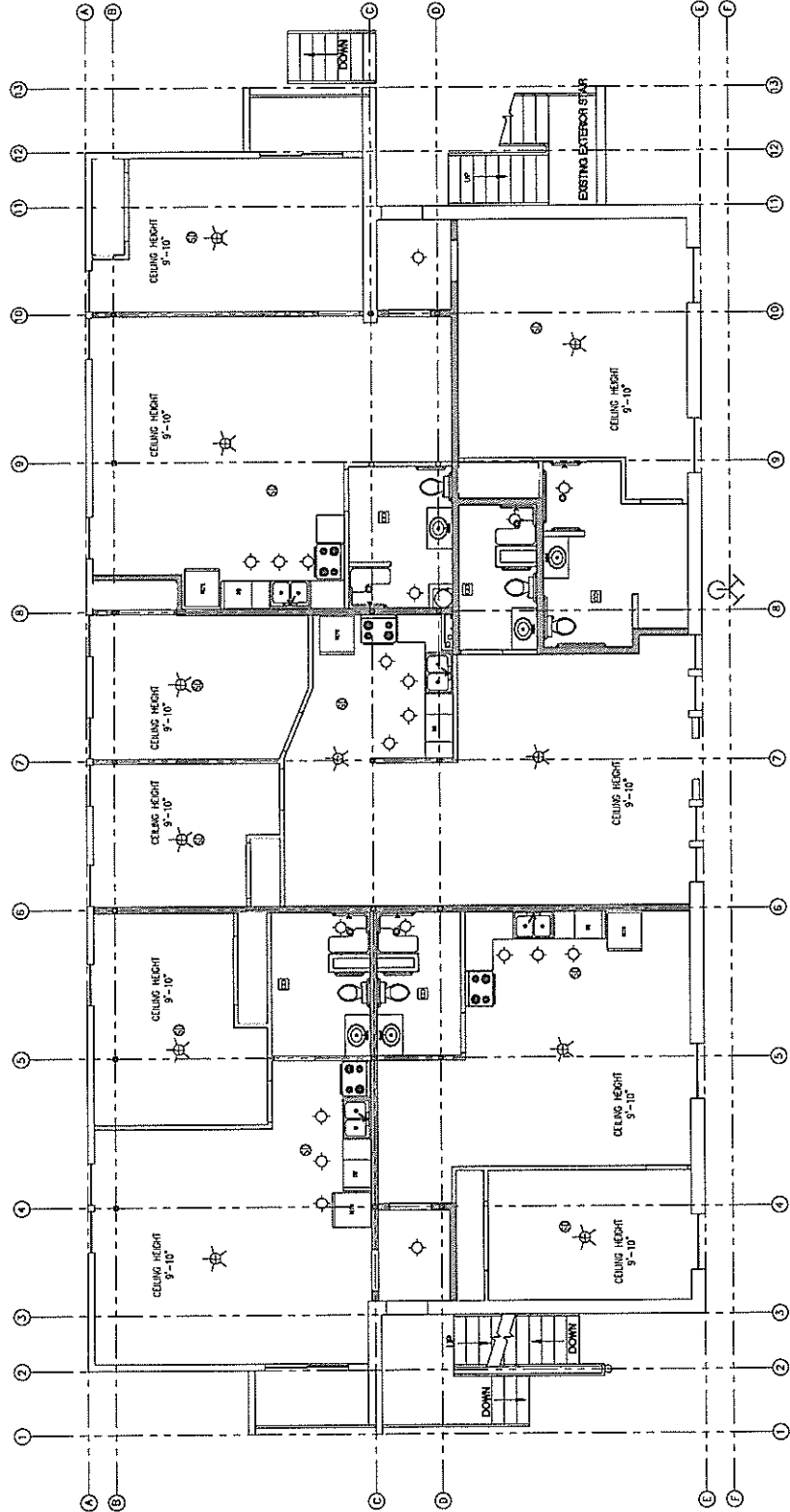

REFLECTED CEILING PLAN LEGEND

- VENTILATION FAN
- 4 INCH LED CAN
- SMOKE DETECTOR
- CEILING LIGHT/FAN

REFLECTED CEILING PLAN
SCALE: 1/4" = 1'-0"

NOTE: FULL SETS ARE 24"x36" HMF SIZE SETS ARE 12"x18" CONFORM SCALES SHOWN ON DRAWINGS



© 2018 BY DUBÉ GROUP, INC.
THIS DRAWING IS THE PROPERTY OF DUBÉ GROUP, INC. AND IS TO BE USED ONLY FOR THE PROJECT AND LOCATION SPECIFICALLY IDENTIFIED HEREON. IT IS TO BE KEPT IN CONFIDENCE AND NOT TO BE REPRODUCED, COPIED, OR TRANSMITTED IN ANY FORM OR BY ANY MEANS, ELECTRONIC OR MECHANICAL, INCLUDING PHOTOCOPYING, RECORDING, OR BY ANY INFORMATION STORAGE AND RETRIEVAL SYSTEM, WITHOUT THE WRITTEN PERMISSION OF DUBÉ GROUP, INC. ANY REPRODUCTION OR TRANSMISSION OF THIS DRAWING WITHOUT THE WRITTEN PERMISSION OF DUBÉ GROUP, INC. IS STRICTLY PROHIBITED. THE USER OF THIS DRAWING AGREES TO HOLD DUBÉ GROUP, INC. HARMLESS FROM AND AGAINST ALL CLAIMS, DAMAGES, LOSSES AND EXPENSES, INCLUDING REASONABLE ATTORNEY'S FEES, THAT MAY BE ASSERTED AGAINST DUBÉ GROUP, INC. BY ANY THIRD PARTY AS A RESULT OF THE USER'S USE OF THIS DRAWING.

PROJECT TITLE:
PHASE 7:
FIRST FLOOR TENANT IMPROVEMENTS
APARTMENTS 4 OFFICE

ARCHITECT:	15-1100
DATE:	11/29/2018
DRAWN BY:	ASH, MS
CHECKED BY:	PRO
REVISIONS:	

SHEET DESCRIPTION:
BATHROOM ELEVATIONS

SHEET NUMBER:
A2.2

- LEGEND:**
- 1. MILD, TEXTURED, PAINTED COP. BAND
 - 2. 5" INTEGRATED COVE BASE SEE DETAIL 4-A&J
 - 3. FINISH BACKING FOR FUTURE GRAB BARS SEE DETAIL 1-A&I
 - 4. GRAB BARS AND BACKING SHALL BE INSTALLED IN UNIT-(OFFICE) RESTROOM SEE DETAIL 1-A&I

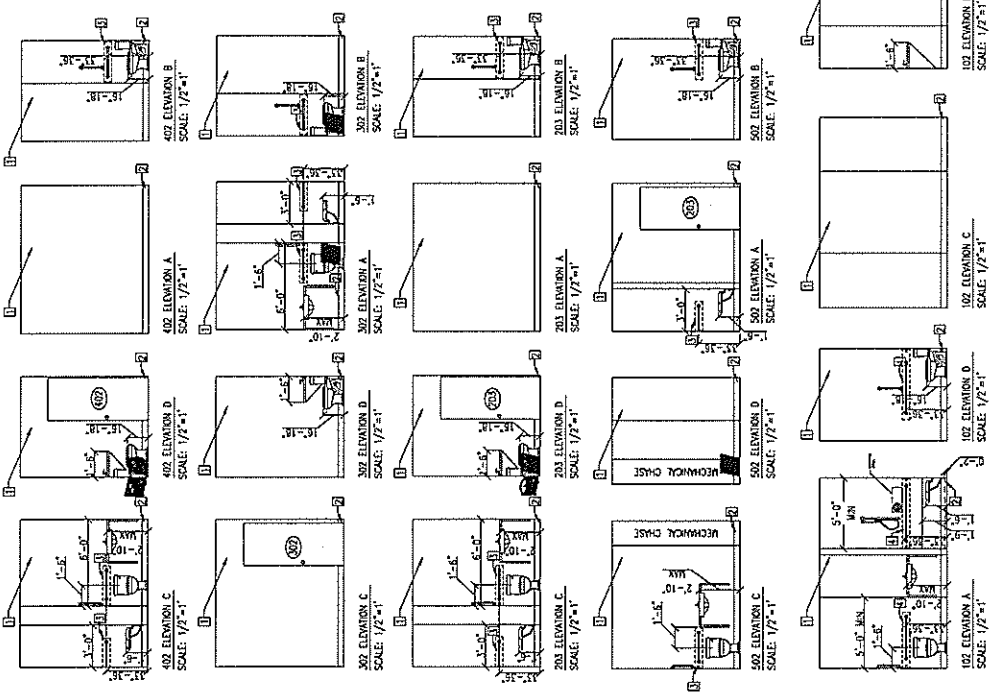

NOTE: FULL SETS ARE 24"X36" H&V. SITE SETS ARE 12"X18" CONFORM SCALES SHOWN ON DRAWINGS



DESIGNER/OWNER/ARCHITECT:
THE HAZARD CONSULTANTS ARCHITECTS AND ENGINEERS, INC.
1400 UNIVERSITY AVENUE, SUITE 1000, PHOENIX, AZ 85016
PH: 602.955.1100 | FAX: 602.955.1101
WWW.HAZCON.COM
REGISTERED PROFESSIONAL ARCHITECT AND ENGINEER
NO. 2443, 11/20/15
STATE OF ARIZONA

PROJECT TITLE:
PHASE 2
FIRST FLOOR TENANT IMPROVEMENTS
FURNITURES & OFFICE

JOB NUMBER: 16-100
DATE: 11/20/2016
DRAWN BY: DAL/JS
CHECKED BY: FRD
REVISED:

SHEET DESCRIPTION:
SECTIONS

SHEET NUMBER:

A3.1

BASE LAYER 5/8" TYPE X GYPSUM WALLBOARD HUNG AT
RIGHT ANGLES TO 2X10 JOISTS 24" O.C. WITH 1/4" TYPE M
OR S DRYWALL SCREWS 24" O.C. FACE LAYER 5/8" TYPE X
GYPSUM WALLBOARD OR GYPSUM VENEER BASE APPLIED AT
RIGHT ANGLES TO JOISTS WITH 1/2" TYPE M OR S DRYWALL
SCREWS 24" O.C. FROM FACE OF WALL. ALL JOIST ENDS
1/2" TYPE C DRYWALL SCREWS 12" O.C. PLACED 2" BACK ON
EITHER SIDE OF END JOISTS. JOISTS OFFSET 24" FROM BASE
LAYER JOINTS. WOOD JOISTS SUPPORTING 1/2" PLYWOOD WITH
SCREWS APPLIED AT RIGHT ANGLES TO JOISTS WITH 8D
WOOD SCREWS 16" O.C. ALL JOIST JOINTS TO BE
PROTECTED FOR FINISHING INCLUDING TRASSES.

SOLID WOOD JOIST FLOOR, 1-1/2" X 9-1/4" JOISTS, SPACED 16"
O.C., 5/8" OSB SUBFLOOR, RESILIENT CHANNELS SPACING SPICED
BELOW. SHEET P" THICKNESS ACOUSTIC BATT INSULATION DOUBLE
LAYER TYPE X GYPSUM BOARD THICKNESS SPICED BELOW.
GYPSUM BOARD THICKNESS: RESILIENT CHANNEL SPACING O.C.
5/8" 24"
1/2" 24"
1/2" 16"

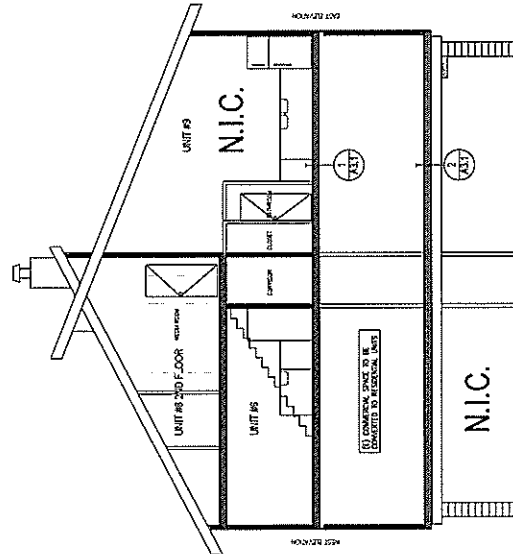
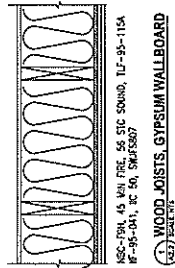
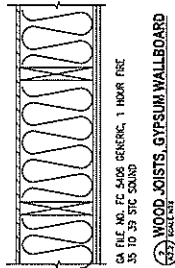

EAST ELEVATION SECTION
SCALE: 3/16" = 1'-0"

NOTE: FULL SETS ARE 24"x36" - HALF SIZE SETS ARE 12"x18" - CONFIRM SCALES SHOWN ON DRAWINGS



© 2017 BY THE DUBÉ GROUP, INC.
THIS DRAWING IS THE PROPERTY OF THE DUBÉ GROUP, INC. AND IS NOT TO BE REPRODUCED OR TRANSMITTED IN ANY FORM OR BY ANY MEANS, ELECTRONIC OR MECHANICAL, INCLUDING PHOTOCOPYING, RECORDING, OR BY ANY INFORMATION STORAGE AND RETRIEVAL SYSTEM, WITHOUT THE WRITTEN PERMISSION OF THE DUBÉ GROUP, INC. THE DUBÉ GROUP, INC. ACCEPTS NO LIABILITY FOR ANY ERRORS OR OMISSIONS IN THIS DRAWING. THE DUBÉ GROUP, INC. IS NOT RESPONSIBLE FOR ANY DAMAGE TO PERSONS OR PROPERTY CAUSED BY THE USE OF THIS DRAWING. THE DUBÉ GROUP, INC. IS NOT RESPONSIBLE FOR ANY DAMAGE TO PERSONS OR PROPERTY CAUSED BY THE USE OF THIS DRAWING. THE DUBÉ GROUP, INC. IS NOT RESPONSIBLE FOR ANY DAMAGE TO PERSONS OR PROPERTY CAUSED BY THE USE OF THIS DRAWING.

PROJECT TITLE
FIRST FLOOR TENANT IMPROVEMENTS
APARTMENTS 4 OFFICE

JOB NUMBER 14-110
DATE 11/28/2016
DRAWN BY ARL MS
CHECKED BY PRO
REVISIONS

SHEET DESCRIPTION:
DETAILS

SHEET NUMBER
A5.1

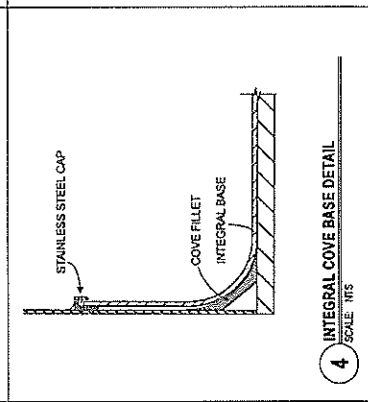
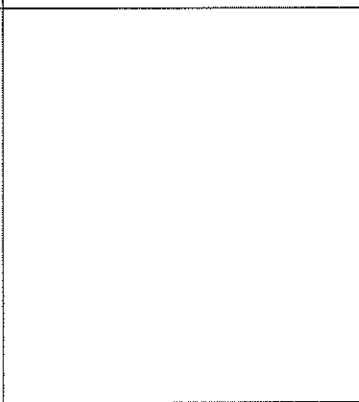
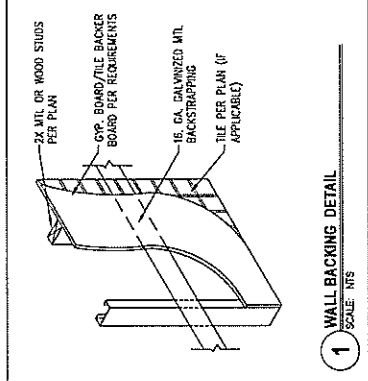
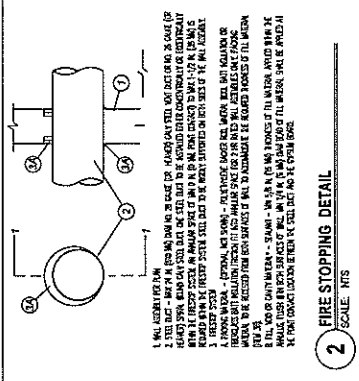
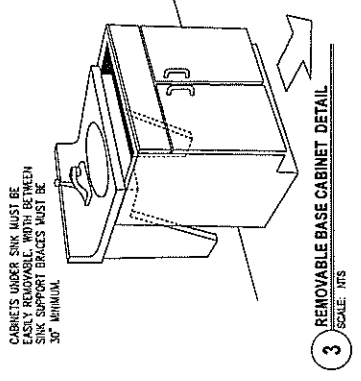

NOTE: FULL SETS ARE 24\"/>



QUESTIONS:
THIS DRAWING IS THE PROPERTY OF DUBÉ GROUP ARCHITECTURE. IT IS TO BE USED ONLY FOR THE PROJECT AND SITE SPECIFICALLY IDENTIFIED HEREON. IT IS NOT TO BE REPRODUCED, COPIED, OR TRANSMITTED IN ANY FORM OR BY ANY MEANS, ELECTRONIC OR MECHANICAL, INCLUDING PHOTOCOPYING, RECORDING, OR BY ANY INFORMATION STORAGE AND RETRIEVAL SYSTEM, WITHOUT THE WRITTEN PERMISSION OF DUBÉ GROUP ARCHITECTURE. ANY UNAUTHORIZED USE OF THIS DRAWING IS STRICTLY PROHIBITED.

PROJECT TITLE:
PHASE 2 -
FIRST FLOOR TENANT IMPROVEMENTS
APARTMENT 103

JOB NUMBER: 16-103
DATE: 1/25/2018
DRAWN BY: JAL/ME
CHECKED BY: PJD
REVISIONS:

SHEET DESCRIPTION:
DOOR SCHEDULE

SHEET NUMBER:
A6.1

SCHEDULE ABBREVIATIONS

- AL ALUMINUM
- GL GLASS
- INS INSULATED
- MTL METAL
- WLD WELDED
- ST STEEL
- WOOD WOOD
- EX EXTERIOR
- INT INTERIOR

LINE	DOOR / LOCATION	TYPE	PR	E1/E2	RATING	DOOR			FRAME			DETAILS		
						HARDWARE	WIDTH	HEIGHT	MAT'L	GLAZING	FINISH	WEATHERSTRIP	THRESHOLD	COMMENTS
4	401 FRONT	1	(N)	20min		3'-0"	6'-8"	WD	PAINTED		X		ADA COMPLIANT	
4	403 BEDROOM	2	(N)	20min		3'-0"	6'-8"	WD	PAINTED		X			
4	402 BATHROOM	2	(N)	20min		3'-0"	6'-8"	WD	PAINTED		X			
4	403-1 CLOSET	4	X	(N)		5'-0"	6'-8"	WD	PAINTED		X		SLIDING	
4	400-1 BALCONY	7	(E1)	20min		3'-0"	6'-8"	WD	PAINTED		X		ADA COMPLIANT	
3	300 FRONT	1	(N)	20min		3'-0"	6'-8"	WD	PAINTED		X			
3	300-2 BEDROOM	2	(N)	20min		3'-0"	6'-8"	WD	PAINTED		X			
3	300-1 CLOSET	4	X	(N)		5'-0"	6'-8"	WD	PAINTED		X		SLIDING	
2	200 FRONT	6	(E1)	20min		3'-0"	6'-8"	WD	PAINTED		X		ADA COMPLIANT	
2	201 BEDROOM	2	(N)	20min		3'-0"	6'-8"	WD	PAINTED		X			
2	202 BEDROOM	2	(N)	20min		3'-0"	6'-8"	WD	PAINTED		X			
2	203 BATHROOM	2	(N)	20min		3'-0"	6'-8"	WD	PAINTED		X			
2	201-1 CLOSET	5	X	(N)		4'-0"	6'-8"	WD	PAINTED		X		SLIDING	
5	500 FRONT	1	(N)	20min		3'-0"	6'-8"	WD	PAINTED		X			
5	500 BEDROOM	2	(N)	20min		3'-0"	6'-8"	WD	PAINTED		X			
5	501-1 CLOSET	4	X	(N)		5'-0"	6'-8"	WD	PAINTED		X		ADA COMPLIANT	
5	501-2 BALCONY	7	(E1)	20min		3'-0"	6'-8"	WD	PAINTED		X		SLIDING	
1	101 FRONT	1	(N)	20min		3'-0"	6'-8"	WD	PAINTED		X		ADA COMPLIANT	
1	102 RESTROOM	2	(N)	20min		3'-0"	6'-8"	WD	PAINTED		X		SLIDING	
1	101-1 CLOSET	4	X	(N)		5'-0"	6'-8"	WD	PAINTED		X		ADA COMPLIANT	
1	101-2 CLOSET	6	(E1)	20min		5'-0"	6'-8"	WD	PAINTED		X		ADA COMPLIANT	
1	VESTIBLE 103	8	(E1)	20min		5'-0"	6'-8"	WD	PAINTED		X		ADA COMPLIANT	

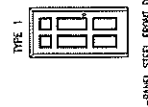
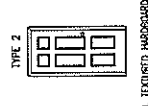
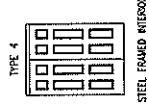
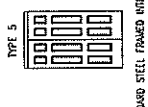
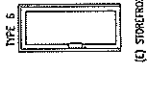
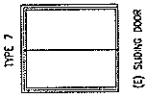

NOTE: FULL SETS ARE 24"X36" HALF SIZE SETS ARE 12"X18" CONFORM SCALES SHOWN ON DRAWINGS

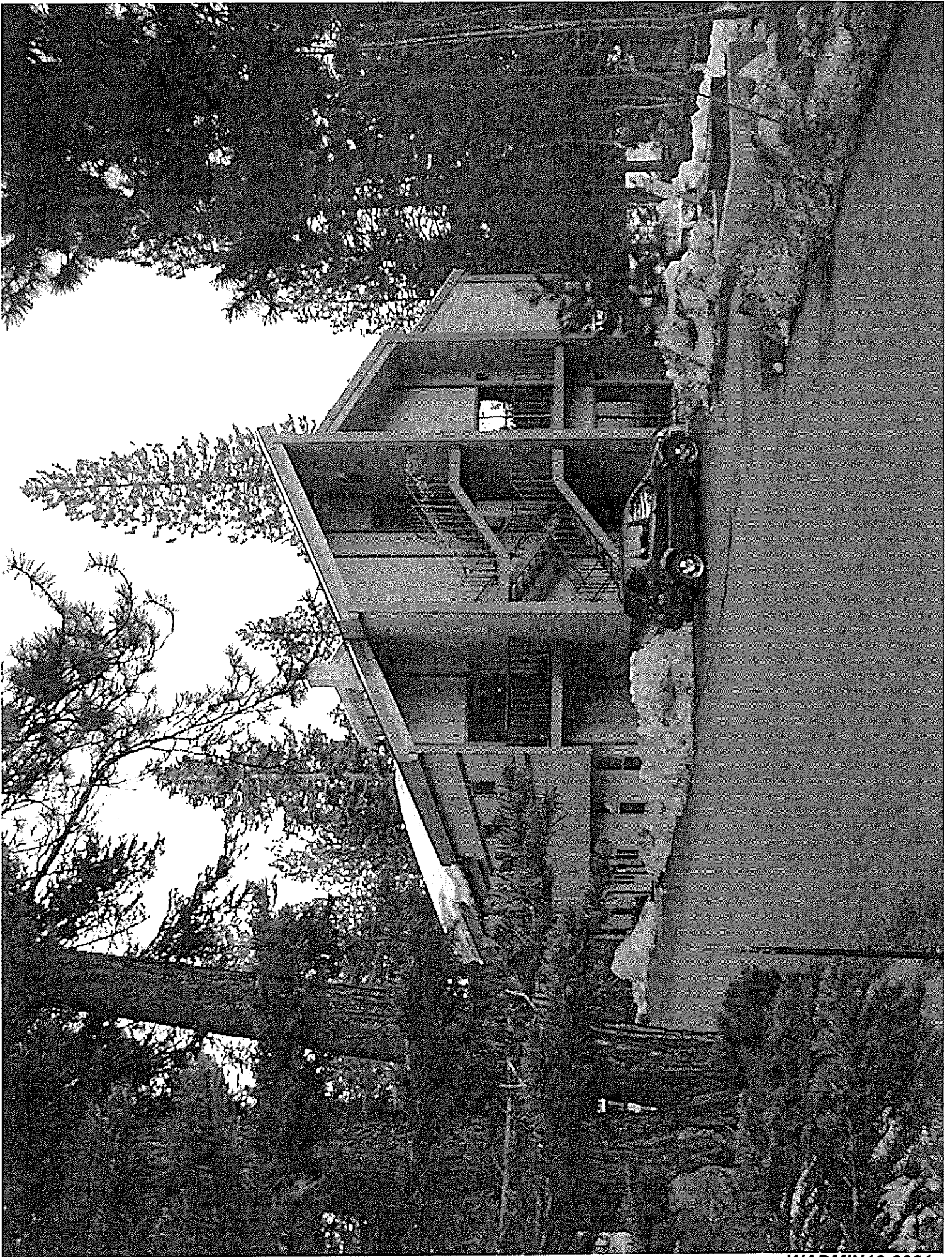

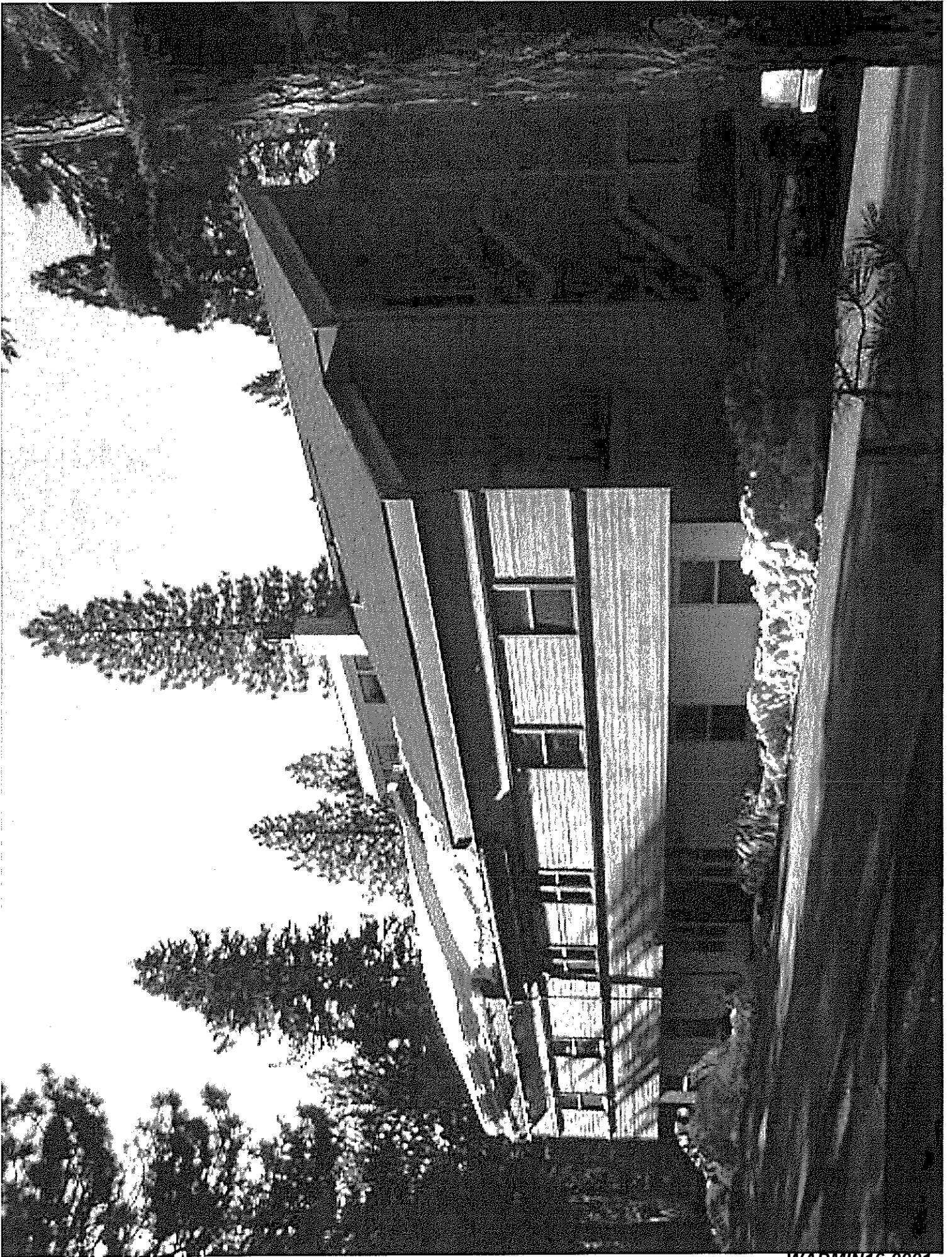

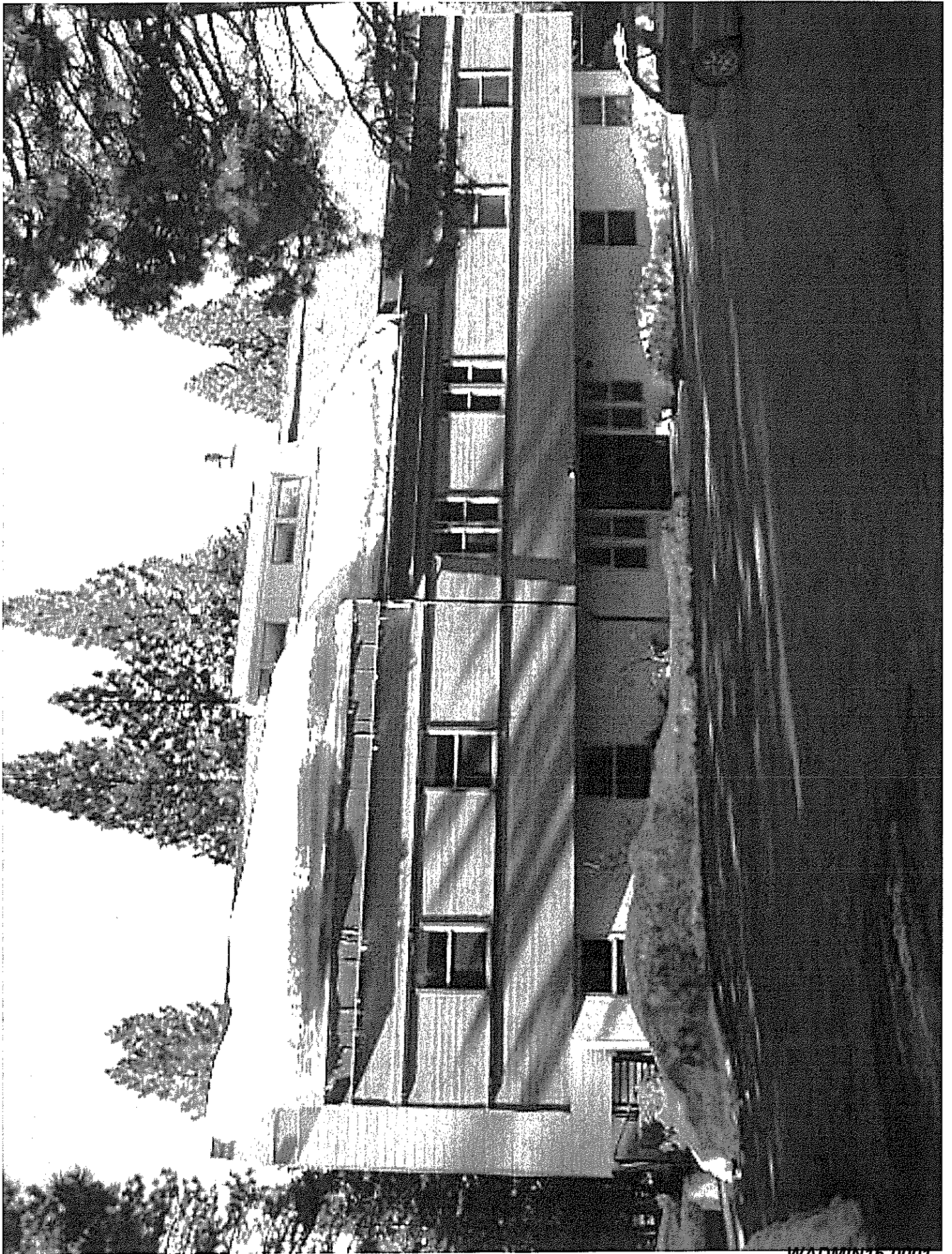

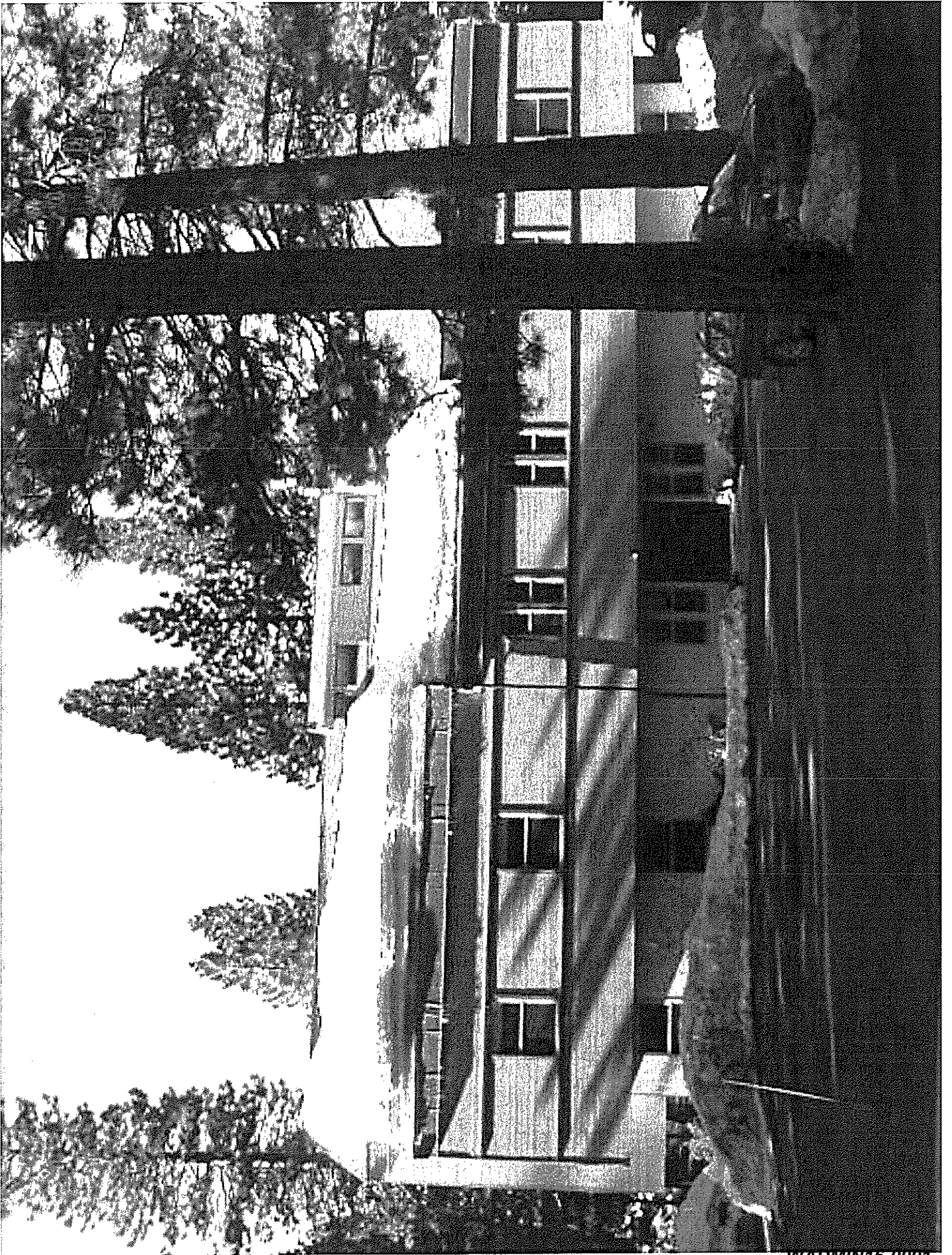

WADMIN16-0001
EXHIBIT D



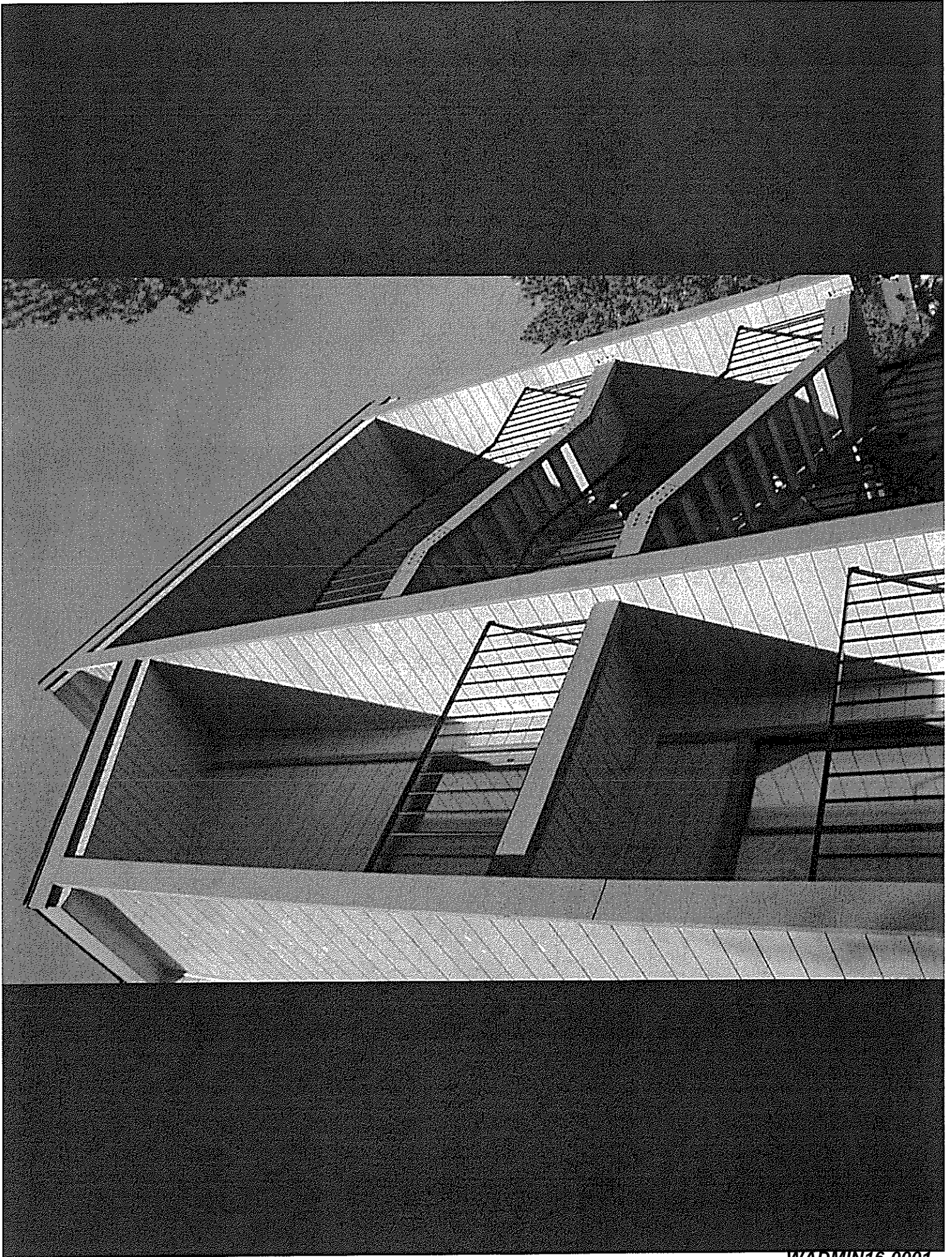

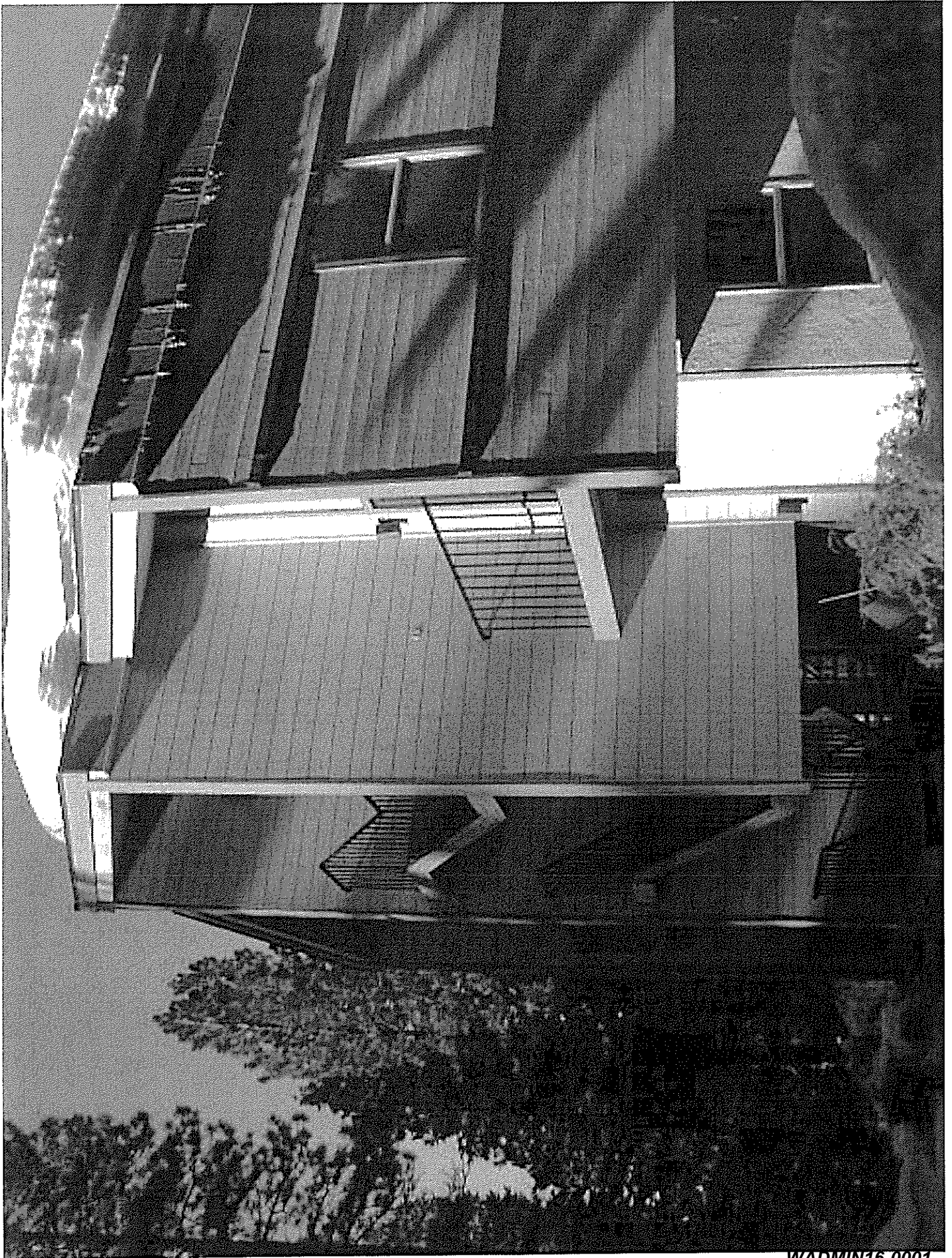



Bradley A. Johnson
Sarah A. Hussong Johnson
PO BOX 5485
Incline Village, NV 89450

January 9, 2017

Mr. Roger Pelham
Senior Planner
Washoe County Planning and Development
PO BOX 11130
Reno, NV 89520

Re: WADMIN16-0001 (Mays Building Residential Conversion)

Dear Mr. Pelham:

As residents of Incline Village and the owners of the adjacent single family dwelling (785 Mays Boulevard), we are writing to express our support for the conversion of commercial office space at 795 Mays Boulevard into additional residential units as well as to express our concerns about the completeness of the project application. The proposed project could provide much needed residential space within the core of Incline Village; however, the project as submitted is inconsistent with the requirements of the Washoe County Code. As we are unable to attend the project's February 2, 2017 public hearing, we request that our written comments on the project application be included in the staff report to the Washoe County Board of Adjustment for their review.

Our concerns fall entirely within the project's compliance with the requirements of the Washoe County Code. We believe the project application, as submitted, fails to address Code requirements in four areas: proposed density, yards/setbacks/screening/landscaping, parking, and existing condition of the exterior of the building.

Proposed Density

The proposed project, as submitted, increases the number of residential units from six (6) units to ten (10) units. Section 110.406.10 of the Washoe County Code stipulates that "requirements for development occurring in the Tahoe area including, but not limited to, building placement standards shall be the most restrictive of Tahoe Regional Planning Agency (TRPA) standards and Washoe County standards."

Chapter 31.3.2 of the TRPA Code of Ordinances (TRPA Code) as well as the applicable Plan Area Statement limits multi-family dwelling density to 15-units per acre. If the property were strictly multi-family dwelling this would limit the property to eight (8) units:

$$15 \frac{\text{units}}{\text{acre}} \times 0.56 \text{ acres} = 8.4 \text{ units}$$

However, the property is mixed-use multi-family residential and commercial (520-square feet of revised commercial office space and 3,170-square feet of existing garages used for commercially leased private parking and personal storage). In this case, TRPA Code Chapter 31.5.2 further limits the density to six (6) units:

$$\frac{9,258 \text{ square feet residential}}{12,948 \text{ square feet total building}} \times 15 \frac{\text{units}}{\text{acre}} = 10.7 \frac{\text{units}}{\text{acre}} \times 0.56 \text{ acres} = 5.99 \text{ units}$$

The proposed project, as currently submitted, is requesting an increase in residential units beyond the allowed maximum densities by four (4) units and by two (2) units if the commercial use were eliminated in a future plan revision. We believe increasing density beyond the code allowed maximums will have a negative impact on the quality of the neighborhood and adjacent property owner land values.

Yards/Setbacks/Landscaping/Screening

Table 110.406.05.1 of the Washoe County Code requires multi-family developments within MDU zoned areas to have five (5) feet side yards/setbacks and a 20 feet rear yard/setback. The proposed plan shows 11 parking spots within the 20 feet rear yard/setback. Additionally, the proposed plan shows five (5) spots abutting the five (5) foot side yard/setback but with no provisions for curb or wheel stops to prevent parking in the side yard. Washoe County Code Section 110.406.25 stipulates that “any yard required by the Development Code shall be open and unobstructed from the ground to the sky” and allowing parking in the rear and side yards would prevent this.

Additionally, Washoe County Code Section 110.412.50.c stipulates when a parking area adjoins a residential use, a landscaped buffer is required as follows:

- 1) The buffer shall be the width of the required yard for the entire length of the adjoining property line; and
- 2) The buffer shall include at least one (1) tree every twenty (20) linear feet, or fraction thereof, planted in off-set rows.

Further, Washoe County Code Section 110.412.50.d stipulates when a parking or loading area adjoins a rear or non-street side yard of a residential use, a solid decorative wall or fence shall be erected along the entire length of the property line. This wall or fence shall be at least six (6) feet but not more than seven (7) feet in height.

The proposed project, as submitted, provides no screening or landscape buffer and proposes parking in the required side and rear yards. While the property presently has some fencing along the rear and side yards, most of it is chain link and the portions of fencing that is solid is in poor condition due to damage from immediately adjacent parking and snow storage. We believe allowing parking in the rear and side yards/setbacks and failure to provide adequate landscaping and screening will have a negative impact on the quality of the neighborhood and adjacent property owner land values. We are particularly sensitive to the screening issue due to the elevation change between parcels; headlights from vehicles parked in or adjacent to the proposed handicap spots shine directly into the windows of our home.

We have attached photos to illustrate our concerns below:

View of 785 Mays from vehicle parked at 795 Mays with headlights on:

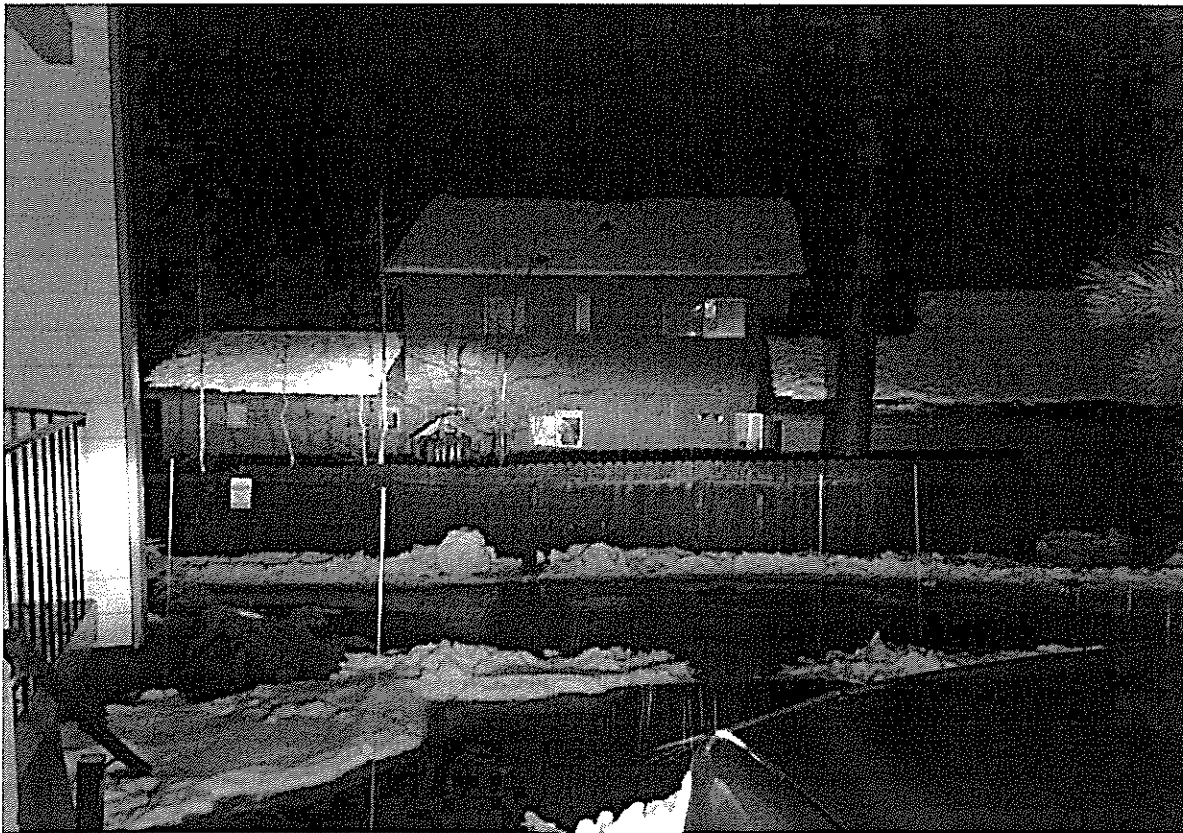

View of vehicle parked at 795 Mays with headlights on from the interior of 785 Mays:



Parking

Washoe County Code Section 110.410.10 stipulates that a multi-family development must have 1.6 parking spots per one (1) bedroom unit, 2.1 parking spots per two (2) bedroom unit; one (1) of which must be in an enclosed garage or carport. While the property appears to have an adequate number of existing exterior parking spots (though none are presently striped in accordance with Washoe County requirements), it is difficult to evaluate the number of spots in the application for the following reasons.

- 1) Access driveways and aisle widths are not dimensioned on the submitted plans.
- 2) Parking spots are shown in the rear yard as discussed earlier in this letter.
- 3) Submitted plans show no accommodation for trash cart storage as required by Incline Village General Improvement District Ordinance 1 – Article 4.1.C or for dumpster storage as required by Article 4.5.B. Trash storage could impact the number of spaces available depending on placement. The existing trash enclosure shown on the submitted

plans is a single bear shed capable of holding totes adequate for two (2) residential units as shown in the photo below:



- 4) Submitted plans show no accommodation for snow storage which impacts exterior parking availability in the winter. See photos below showing existing conditions:

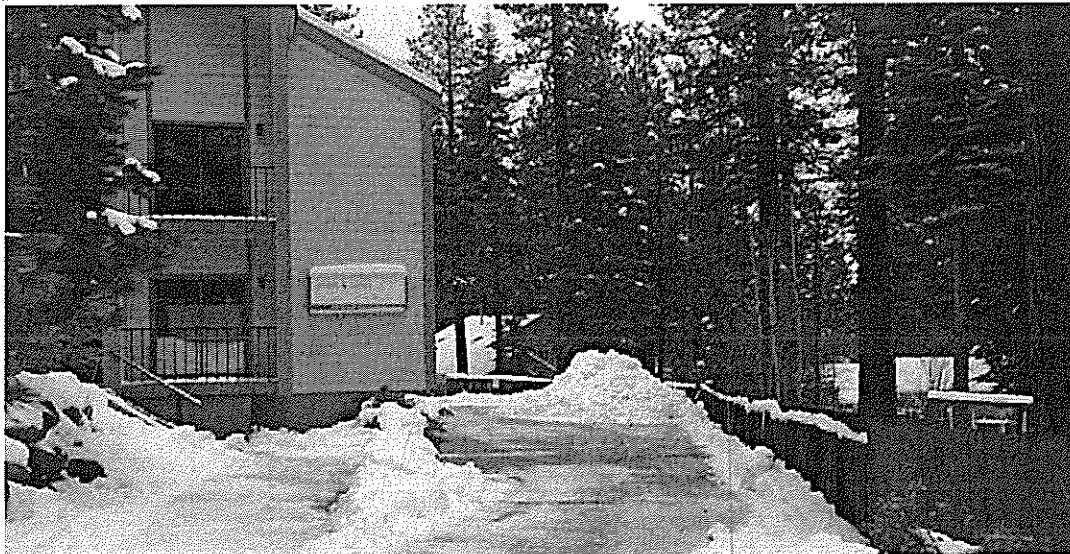



Additionally, the proposed project, as submitted, provides no enclosed garage or carport parking as required by Washoe County Code Section 110.410.10. While the property has seven (7) existing garages, they are presently leased commercially for private parking and personal storage and are not included in the application's parking calculations. If the garages are to be included in the residential unit parking allotment, there are still an inadequate number of enclosed or covered spots relative to the proposed number of multi-family residential units.

We believe providing an inadequate number of exterior and enclosed/covered parking spots will push parking to the Washoe County Right-of-Way (ROW) which is already congested in the

neighborhood. Parking in the ROW adjacent to the property will have a negative impact on the County's ability to provide adequate snow removal and stormwater drainage as well as a negative impact on the quality of the neighborhood and adjacent property owner land values.

Existing Condition of the Exterior of the Building

The proposed project, as submitted, proposes no improvements to the exterior of the building which is in poor condition and in need of maintenance. Washoe County Code Section 50.304.3 defines blight as "conditions that substantially impair the livability of or community appearance of, or the safe, social or economic conditions of, the surrounding neighborhood or county community as stated in NRS 279.388, as amended. Such conditions include, without limitation, the accumulation of debris-refuse-rubbish; broken, rotting, crumbling, cracking or rusting fencing; broken windows; landscaping that is dead or dying, or exhibits uncontrolled growth; and any other similar conditions of disrepair and deterioration." Further, Section 50.308.2.c states "In the unincorporated area of the county, a public nuisance is anything described in the Code as such and is further defined as maintenance of property, or any structure, in such a state of disrepair or deterioration that could cause or contribute to blight and cause a substantial reduction of economic value of neighboring properties."

The following photos document the existing condition of the exterior of the property which shows peeling paint, rotting siding and trim materials, exposed wiring, and broken doors and windows:

WADMIN16-0001 (Mays Building Residential Conversion)

January 9, 2017

Page 8

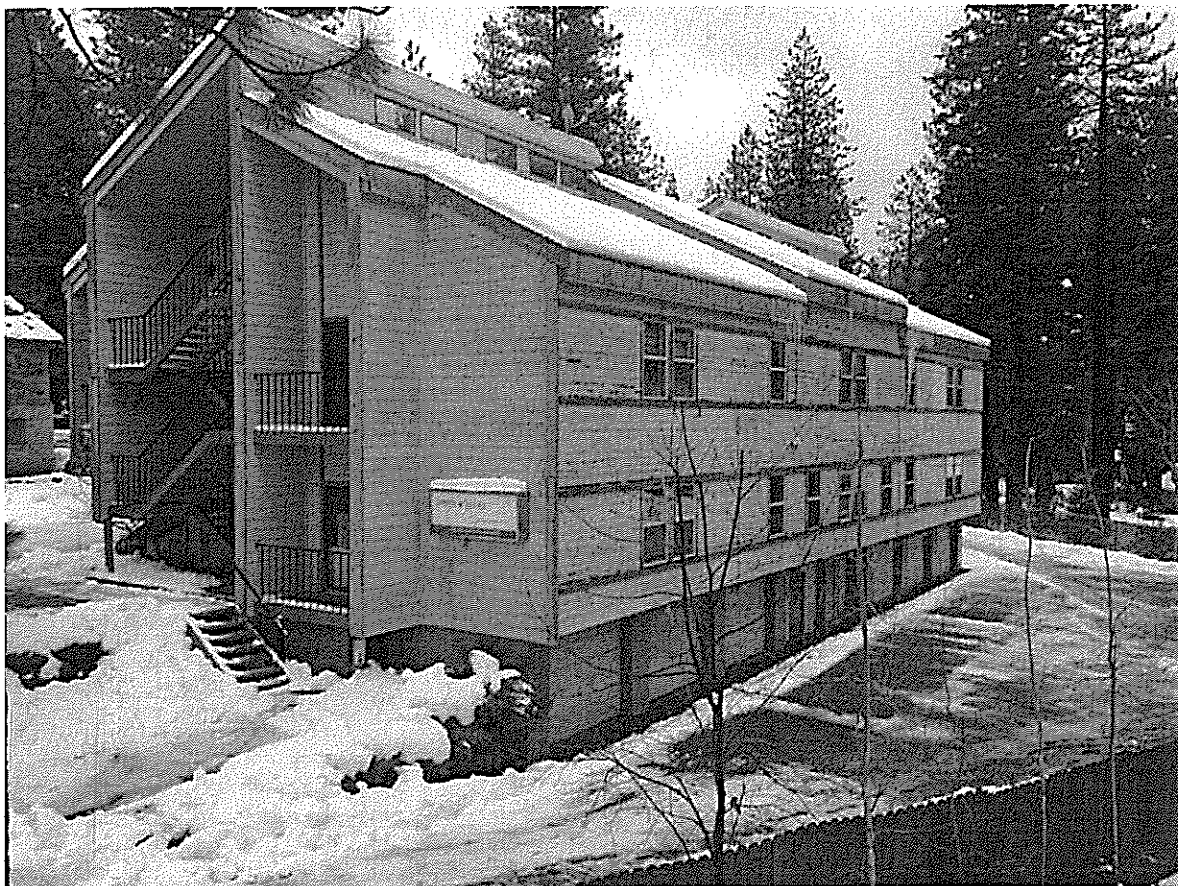





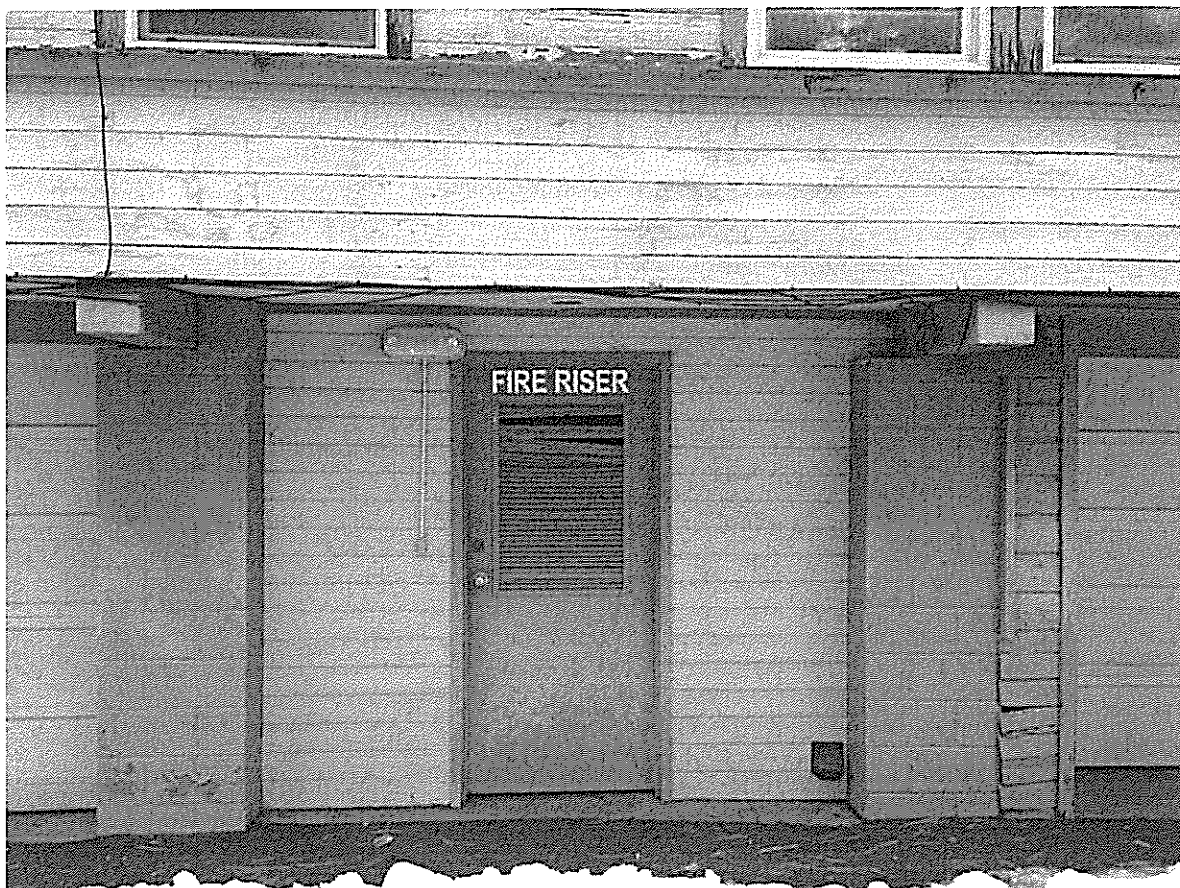



WADMIN16-0001 (Mays Building Residential Conversion)

January 9, 2017

Page 13

We believe an approved project should include a requirement for exterior maintenance and improvements to address the existing property condition which, at present, negatively impacts the quality of the neighborhood and adjacent property owners.

We appreciate your consideration of our comments on the proposed project. We respectfully request that the enclosed comments be addressed and that the proposed project be brought into compliance with Washoe County Code prior to project approval by the Washoe County Board of Adjustment.

Sincerely,



Bradley A. Johnson



Sarah A. Hussong Johnson

CC: Tim Carlson, Carlson & Associates